



AKUOWA3E25COM11 DB DB  
KUOW RADIO  
D S SD UNIV OF WASH  
325 COMMUNICATIONS BLDG  
SEATTLE WA 98105  
JAN 79

# Here's how useful a distortion analyzer can be

Monitor voltage, power, distortion or dB ratio.

No manual nulling controls required (the 1710A is always in auto-null, reaches a null in less than 5 seconds).

Intermodulation Distortion Analyzer optionally available.

Oscillator distortion is typically .001%.

Measure generator signal at load with the push of a button.

Selectable 18 dB per octave filters reject hum and high frequency noise.

Fast pushbutton operation lets you set level, measure voltage or power, then measure distortion.

Measure voltage or power from 10 Hz to 110 kHz.

100 k $\Omega$  Balanced Input.

View input signal on a scope.

Automatic Set Level is optionally available.

View distortion products on a scope.

Measure distortion down to .002%, voltage or S/N ratios with 100 dB dynamic range.

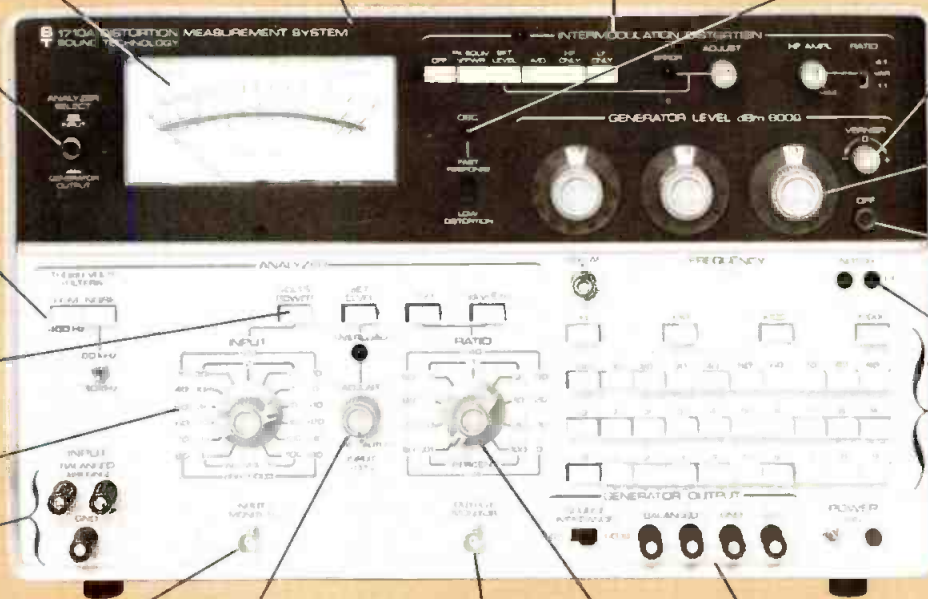

$\pm 1$  dB Vernier adds fine level control.

Internal oscillator adjustable from +26 dBm to -89.9 dBm in 0.1 dB steps.

Turn off oscillator for quick S/N measurement.

Tuning indicators help measure distortion of an external source.

Simultaneously select oscillator and analyzer frequency with fast-to-use pushbuttons. 10 Hz to 110 kHz.

Balanced and floating 150 $\Omega$  or 600 $\Omega$  Generator output.

Two of the above features are so outstandingly valuable that we especially invite your attention to them.

One is the fast, easy measuring you get with pushbutton-selected distortion-measuring circuits (signal source and measuring circuits are simultaneously selected with the **same** pushbuttons). Pushbuttons make it so simple to measure quickly and to repeat measurements.

Secondly, you can drive virtually any type of circuit from the signal source output — whether

balanced, unbalanced, off-ground or whatever. That's because the signal source output circuit is **fully isolated and balanced**.

**There is no output transformer** to introduce noise or distortion.

Besides these outstanding conveniences, you can have the Sound Tech 1710A with an option that enables you to measure **intermodulation distortion**.

Call Mike Hogue/Larry Maguire to get full information on an instrument recognized everywhere as the standard of the audio field.

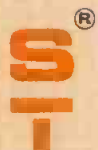

**SOUND TECHNOLOGY**

1400 DELL AVENUE  
CAMPBELL, CALIFORNIA 95008  
(408) 378-6540

Circle 10 on Reader Service Card

## Coming Next Month

- The subject is DISC RECORDING.
- PETER SKYE has submitted an article that examines the need for and ways of achieving disc center accuracy.
- STAN RICKER of the JVC Cutting Center in Los Angeles has written a fully illustrated paper on half speed cutting and makes a case for its more extensive use.
- GEORGE ALEXANDROVICH returns to our pages with an article entitled The Story of a Forgotten Stamper in which he describes the development and application of a new stylus configuration that can play a stamper or mother directly.
- CHARLES REPKA visited a major New York disc mastering house and has prepared a study of this important aspect of the audio business.
- Coming in September in **db**, The Sound Engineering Magazine.

## About The Cover



• The cover is of a Grand "Robeyphone" manufactured by Charles T. Robey, Ltd. The exact date of manufacture is not known. There is an error in the photo. The disc on the platter is an Edison vertical cut, but the Robeyphone was designed only for horizontal cuts. We want to thank the **Audio Technica Company** in the U.S. and Japan. The photo itself is by **SUSUMO ENDO** and was taken in Japan.



THE SOUND ENGINEERING MAGAZINE

AUGUST 1977 VOLUME 11, NUMBER 8

|    |  |
|----|--|
| 32 | THE EQUALIZATION MYTH<br>Alan Fierstein            |
| 34 | MUSIC ALFRESCO IN CENTRAL PARK<br>Martin Dickstein |
| 38 | db Test—BGW POWER AMPLIFIER                        |
| 2  | ADVERTISERS INDEX                                  |
| 4  | CALENDAR   |
| 8  | BROADCAST SOUND<br>Patrick S. Finnegan             |
| 16 | THEORY AND PRACTICE<br>Norman H. Crowhurst         |
| 22 | THE SYNC TRACK<br>John M. Woram                    |
| 24 | SOUND WITH IMAGES<br>Martin Dickstein              |
| 26 | NEW PRODUCTS AND SERVICES                          |
| 41 | CLASSIFIED   |
| 44 | PEOPLE, PLACES, HAPPENINGS                         |

**db is listed in Current Contents: Engineering and Technology**

**Larry Zide**      **John M. Woram**  
EDITOR-PUBLISHER      ASSOCIATE EDITOR

**Bob Laurie**      **Hazel Krantz**  
ART DIRECTOR      COPY EDITOR

**Eloise Beach**      **Lydia Anderson**  
CIRCULATION MANAGER      BOOK SALES

**Ann Russell**      **Crescent Art Service**  
ADVERTISING PRODUCTION      GRAPHICS AND LAYOUT

db, the Sound Engineering Magazine is published monthly by Sagamore Publishing Company, Inc. Entire contents copyright © 1977 by Sagamore Publishing Co., Inc., 1120 Old Country Road, Plainview, L.I., N.Y. 11803. Telephone (516) 433 6530. db is published for those individuals and firms in professional audio-recording, broadcast, audio-visual, sound reinforcement, consultants, video recording, film sound, etc. Application should be made on the subscription form in the rear of each issue. Subscriptions are \$7.00 per year (\$14.00 per year outside U.S. Possessions, Canada and Mexico) in U.S. funds. Single copies are \$1.00 each. Controlled circulation paid at Brattleboro, VT 05301. Editorial, Publishing, and Sales Offices: 1120 Old Country Road, Plainview, New York 11803. Postmaster: Form 3579 should be sent to above address.

**The best is now more affordable**

**lexicon**

MODEL 102 STEREO  
DIGITAL DELAY SYSTEM

If you're after a bigger share of the recording business, we've just made things a lot easier for you.

Our new lower price tag significantly lowers the cost of our Delta-T 102 Series Digital Delays putting them in reach of those studios, that up till now, have found this equipment beyond their budgets.

You get a lot for your money. Our 102-S is the cleanest-sounding unit made. The most versatile. The most exciting to work with. You get two independent delay lines in a single chassis. Couple them with our new VCO module and you get special effects like you never had before: vibrato, doubling with time delay and pitch shift, time delay panning, doppler shift, and a whole lot more.

You can start with the basics, if you wish, and build as you go—thanks to Delta-T's cost-saving modular design. Our 102-S bulletin has the whole story. We'll send you our new prices, application brochure, and a demo record. A note on your letterhead brings you all four. Write today.

**lexicon**

60 Turner Street, Waltham,  
Massachusetts 02154  
(617) 891-6790



Export agent Gotham Export Corporation 741 Washington Street, New York, New York 10014

Circle 12 on Reader Service Card

www.americanradiohistory.com

## index of advertisers

|                                   |            |
|-----------------------------------|------------|
| Ampex . . . . .                   | 9, 30 & 31 |
| Audio Distributors . . . . .      | 23         |
| BTX . . . . .                     | 23         |
| Clear-Com . . . . .               | 14         |
| Communications Co. . . . .        | 22         |
| Community Light & Sound . . . . . | 13         |
| Garner Industries . . . . .       | 27         |
| H-M Electronics . . . . .         | 18         |
| Ivie Electronics . . . . .        | 7          |
| JBL . . . . .                     | Cover 4    |
| K & L Pro Audio . . . . .         | 20         |
| Lexicon . . . . .                 | 2          |
| Orban-Parasound . . . . .         | 5, 19      |
| Recording Supply Co. . . . .      | 22         |
| SAE . . . . .                     | 15         |
| Sennheiser . . . . .              | 4          |
| Showco . . . . .                  | Cover 3    |
| Shure Brothers . . . . .          | 11         |
| SME . . . . .                     | 8          |
| Soundcraft . . . . .              | 17         |
| Sound Technology . . . . .        | Cover 2    |
| Sound Workshop . . . . .          | 21         |
| Standard Tape Labs . . . . .      | 10         |
| Studer-Revox . . . . .            | 3          |
| Tara Audio . . . . .              | 24         |
| The Mix . . . . .                 | 21         |
| UREI . . . . .                    | 6          |
| Waters Manufacturing . . . . .    | 18         |
| White Instruments . . . . .       | 12         |
| Woram Audio . . . . .             | 26         |
| Yamaha . . . . .                  | 19         |



sales offices

### THE SOUND ENGINEERING MAGAZINE

#### New York

1120 Old Country Rd.  
Plainville, N.Y. 11803 516-433-6530

#### Roy McDonald Associates, Inc. Dallas

Stemmons Tower West, Suite 714  
Dallas, Texas 75207 214-637-2444

#### Denver

3540 South Poplar St.  
Denver, Colo. 80237 303-758-3325

#### Houston

3130 Southwest Freeway  
Houston, Tex. 77006 713-529-6711

#### Los Angeles

500 S. Virgil, Suite 360  
Los Angeles, Cal. 90020 213-381-6106

#### Portland

2035 S. W. 58th Ave.  
Portland, Ore. 97221 503-292-8521

#### San Francisco

Suite 265, 5801 Christie Ave.  
Emeryville, Cal. 94608 415-653-2122



GRAND OLE OPRY  
THE FAMILY REUNION

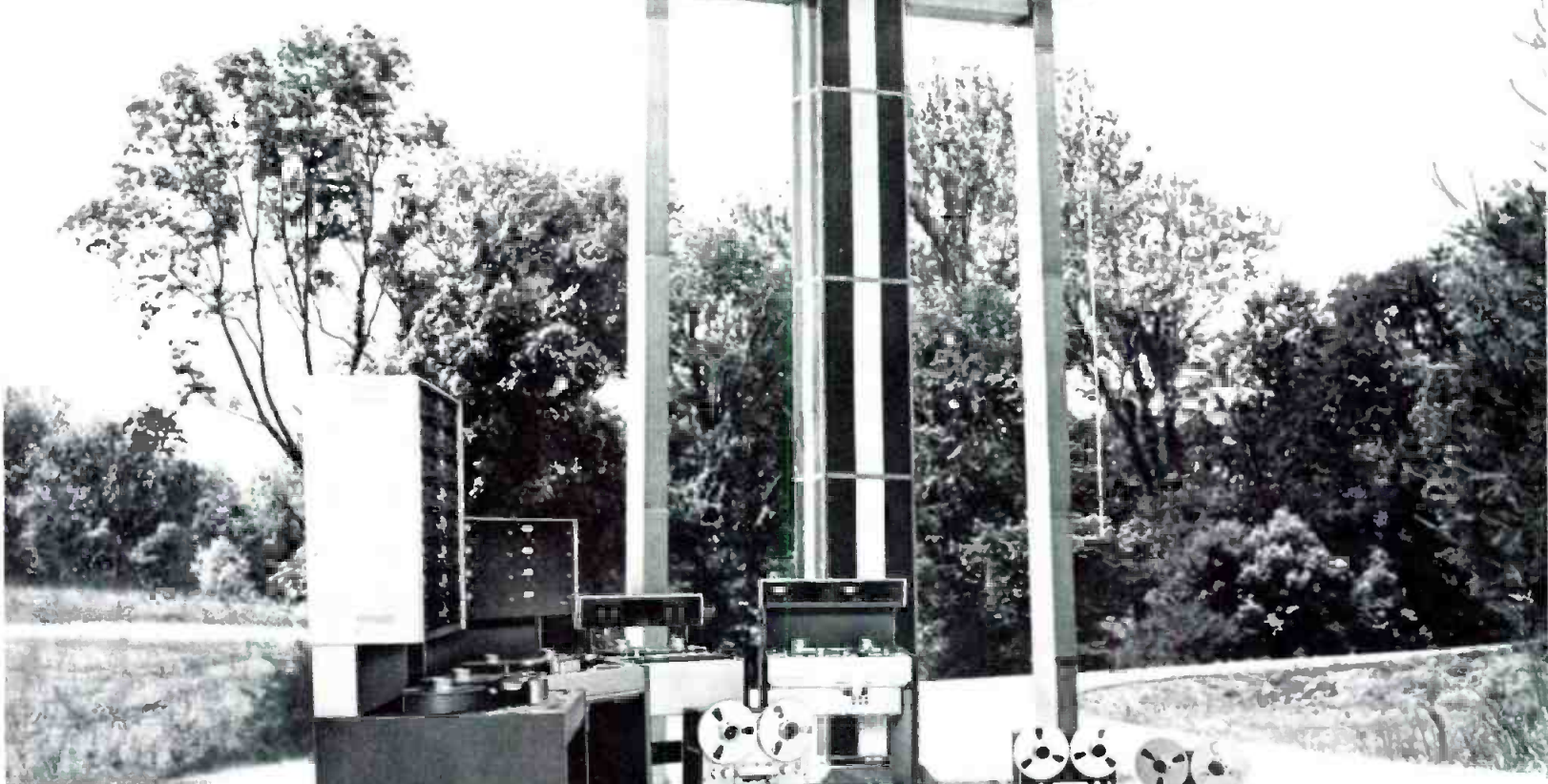

### The most exciting new recording combo in Music City

Willi Studer's Revox family of tape recorders and components for the audiophile has joined Willi Studer's family of professional audio equipment to form Studer Revox America, Inc., in Nashville, Tennessee USA.

This provides all Revox audiophile and institutional users the obvious benefits of factory direct sales and service enjoyed by professional studios and broadcasters.

# STUDER REVOX

Studer Revox America, Inc., 1819 Broadway, Nashville, Tenn. 37203 / (615) 329-9576 • In Canada: Studer Revox Canada, Ltd. / (416) 423-2831

Circle 16 on Reader Service Card

[www.americanradiohistory.com](http://www.americanradiohistory.com)

# AND NOW, A WORD ABOUT OVERLOAD, FROM SENNHEISER'S MD 421:

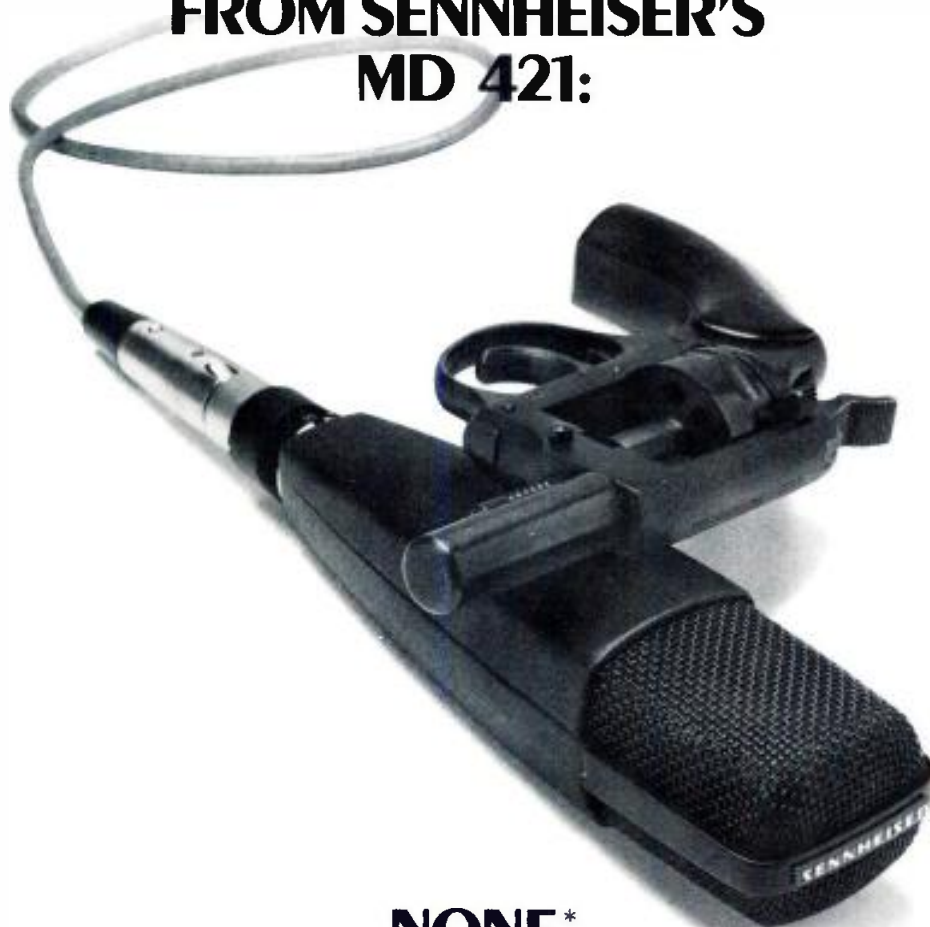

## NONE.\*

A lot of engineers are worried about overload these days. And no wonder: Rock groups. Country groups. Jetports. And other high program and ambient sources make it more necessary than ever for microphones to be overload-free as well as accurate.

Like our tough MD 421 cardioid dynamic.

In this test with a starter's pistol, we measured an instantaneous sound-pressure level of some 175 dB—well beyond what any musical instrument or voice can pro-

duce—while the oscillogram measured no clipping or ringing.

Whether you need a microphone to capture transient sound like this pistol shot, or "face the music" on stage at 130+ dB in a disco or recording session, consider our MD 421. You'll discover its precise cardioid directionality, rugged design and wide, smooth response are ideal for rock-concert, recording and broadcast applications.

The price won't overload you either.

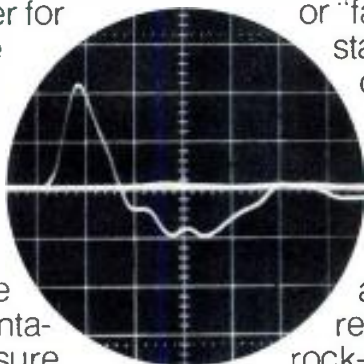

\*Outdoor test with Tektronix scope, set for 10V/division vertical, 01.  $\mu$ sec/div, horizontal: 22 cal starter's pistol mounted 15 cm from MD 421 measured pressure of 111,000 dynes/cm<sup>2</sup> (175 dB SPL). Smooth, rounded scope trace indicates total lack of distortion.

 **SENNHEISER**  
ELECTRONIC CORPORATION

10 West 37th Street, New York 10018 (212) 239-0190  
Manufacturing Plant Bissendorf/Hannover West Germany

Circle 25 on Reader Service Card

## db Calendar

### AUGUST

- 22-23 **N.Y.U. Seminar on R&D Management.** Contact: Ms. Heidi Kaplan, N.Y. Management Center, 360 Lexington Ave., New York, N.Y. 10017. (212) 953-7262.
- 27-29 **National Music & Sound Show.** Hilton Hotel, New York City. Contact: Music Retailer, 50 Hunt St., Watertown, Ma. 02172. (617) 926-3770.

### SEPTEMBER

- 12-18 **International Audio Festival and Fair.** Olympia, London, U.K. Contact: British Information Services, 845 Third Ave., New York, N.Y. 10022. (212) 752-8400.
- 13-15 **Synergetic Seminar,** Kansas City, Mo. Contact: Don Davis, Synergetic Audio Concepts, P.O. Box 1134, Tustin, Ca. 92680. (714) 838-2288.
- 20-22 **Synergetic Seminar,** Syracuse, N.Y.
- 27-29 **Synergetic Seminar,** New York, N.Y.
- 16-18 **Consumer Hi-Fi Show.** Sheraton Motor Inn, New York, N.Y. Contact: Charles Ray, Communications Show Corp. 30 E. 42nd St., Suite 1620, New York, N.Y. 10017. (212) 986-7592.
- 26,27 **Electronic Representatives Assoc. Show.** Statler Hilton Hotel, New York City. Contact: Gil Miller c/o Gilbert E. Miller Assoc. 375 N. Broadway, Jericho, N.Y. 11753.

### OCTOBER

- 5-7 **Synergetic Seminar,** Boston, Mass. Contact: Don Davis, Synergetic Audio Concepts, P.O. Box 1134, Tustin, Ca. 92680. (914) 838-2288.
- 18-20 **Synergetic Audio Seminar.** Philadelphia, Pa.
- 5-9 **Hobby Electronic Fair,** O'Hare Exposition Center, Chicago, Ill. Contact: Industrial & Scientific Conference Management, Inc., 222 W. Adams St., Chicago, Ill. 60606.
- 15-19 **Instrumentation - Automation Conference.** Philadelphia Civic Center, Philadelphia, Pa. Contact: Instrument Society of America, 400 Stanwix St., Pittsburgh, Pa. 15222. (412) 281-3171.

(continued)

# The Professional's Parametric

Introducing the 622 . . . a Parametric Equalizer with even better performance and more cost-effectiveness than its highly reliable predecessor. Improved manufacturing efficiency and state-of-the-art componentry help us provide more for less money.

We've added a host of features important to you—the professional user. The 622 now includes in/out switches for each band, balanced inputs (with transformer-balanced output optional), extensive RF protection, and the latest FET-input opamps which reduce transient intermodulation to the vanishing point and which provide THD guaranteed less than 0.025%, 20-20,000 Hz at +18 dBm output. A 115/230 volt 50-60 Hz AC power supply is now standard. A new proprietary parametric bandpass filter has been designed which virtually eliminates the effects of control wear and complements the notching capability of

our “constant-Q” design by enabling 40 dB notches to be consistently obtained.

The 622 is backed by an outstanding quality control program, including the use of burned-in, hermetically-sealed IC's, and further burn-in procedures on the entire equalizer. We know this is important to you when your equalizer doesn't fail in front of an arena audience of 5,000 people . . . or on the air in drive-time . . . or in the middle of a critical mix. This combination of unbeatable performance and quality makes the 622 the *professional's choice*.

Your Orban/Parasound dealer has all the details. Write us for his name and a brochure with the complete 622 story.

**orban/parasound**

680 Beach Street  
San Francisco, CA 94109  
(415) 673-4544



# LA-4 Son of LA-3A

The LA-4 Compressor/Limiter is another great UREI performer. It offers advanced IC design, added features, and a lower price. The LA-4's new electroluminescent light source, the heart of its patented Electro-Optical attenuator, is an L.E.D. which will not change or deteriorate with age. Compression ratios are adjustable from a soft, smooth 2:1 compression through super tight sounding 20:1 limiting. The natural sounding RMS gain control action makes it ideal for professional recording and re-recording. Half rack size. Priced under \$350.00.

Available from your UREI dealer.

**UREI**  
QUALITY  
OF COURSE



8460 San Fernando Road, Sun Valley, California 91352 (213) 767-1000

Exclusive export agent: Gotham Export Corporation, New York

Circle 30 on Reader Service Card

calendar (cont.)

- 11-12 **Sound Business Show** (ERA Consumer Products Div.) Rodger Young Ctr., Los Angeles, Ca. Contact: Alan Gediman, Marshank Sales (213) 559-2591.
- 16-21 **SMPTE Technical Conference & Equipment Exhibit.** Century Plaza Hotel, Los Angeles, Ca. Contact: SMPTE, 862 Scarsdale Ave., Scarsdale, N.Y. 10583.
- 18-20 **Western Educational Society for Telecommunications Conference.** Harrah's Hotel, Reno, Nevada. Contact: Wendell H. Dodds, Radio-Television Ctr., University of Nevada 89557.
- 25-26 **New York University R&D Management Seminar.** Chicago, Ill. Contact: Heidi Kaplan, New York Management Center, 360 Lexington Ave., New York, N.Y. 10017. (212) 953-7262.

#### NOVEMBER

- 2-9 **Synergetic Seminar,** Washington, D.C. Contact: Don Davis, Synergetic Audio Concepts, P.O. Box 1134, Tustin, Ca. 92680. (714) 838-2288.
- 2-6 **Dixie Electronics Representatives Convention.** Boca Raton Hotel & Club, Boca Raton, Fla. Contact: Kimball P. Magee, Dixie Elec. Reps. Inc. 1611 Perimeter Center E., Atlanta, Ga. 30346.
- 4-7 **Audio Engineering Society Convention and Show,** Waldorf-Astoria, New York, N.Y. Contact: A.E.S., 60 E. 42nd St., Rm. 449, New York, N.Y. 10017. (212) 661-8528.
- 7-8 **N.Y.U. R & D Seminar.** Los Angeles, Ca. Contact: Heidi E. Kaplan, New York Management Center, 360 Lexington Ave., New York, N.Y. 10017. (212) 953-7262.
- 10 **Society of Broadcasting Engineers, N.Y. Chapter meeting.** WQXR Presentation Theater, N.Y. Times Building, 230 W. 43rd St., New York, N.Y. 7:30 p.m. (Cafeteria dinner available.) Speaker: Ron Simon. Contact Tom Padwa.
- 14-17 **B&K Seminar, Acoustical Materials.** Cleveland, Ohio. Contact: B&K Instruments, 5111 W. 164th St., Cleveland, Ohio 44142. (216) 267-4800.
- 15-17 **Synergetic Seminar.** Nashville, Tenn. See above.
- 29- **Synergetic Seminar.** Orlando, Fla. See above.



# Unplug it with Ivie.

Ivie just eliminated the power line cord on professional audio test equipment. Our state-of-the-art designs are going portable. You can leave those heavy boxes and their extension cords in the office, because the new IE-10A Audio Spectrum Analyzer puts audio analysis in the palm of your hand.

The IE-10A is an extremely versatile audio analyzer combining the power of a sound level meter with that of an octave bandwidth spectrum analyzer. Calibrated in both dB SPL and dBm, the unit measures a broad variety of signals quickly and accurately.

The built-in calibration microphone is equalized to the IE-10A case to ensure flatness. An external input is provided for on-line signal monitoring and use with other types of microphones.

From the equalization of rooms, speakers and tape recorders to noise analysis and sound pressure level testing, the IE-10A is an audio pro. Using inexpensive accessories the IE-10A will also measure amplifier power, voltage and total harmonic distortion.

If you think our specifications are impressive . . . you should check out the prices! So get "unplugged" with an IE-10A. Ask us for a brochure, or see your local Ivie dealer for a demonstration.

## Spec Briefs

Frequency Range 22Hz - 22KHz.  
45 dB "on-screen" display range.  
Ten octave channels w/160 LEDs.  
Selectable 1, 2 or 3 dB resolution.  
Calibrated 45 to 140 dB SPL (A or C).  
Calibrated - 116 to +9 dBm.  
Rechargeable Nickel - Cadmium batteries.  
Weight is 15 ozs. (430 gms).

For free literature and data, contact:



IVIE ELECTRONICS, INC.  
500 West 1200 South  
Orem, Utah 84057  
(801) 224-1800

Or return the reader service card.

The IE-10A . . .  
a complete audio analysis system  
in the palm of your hand.

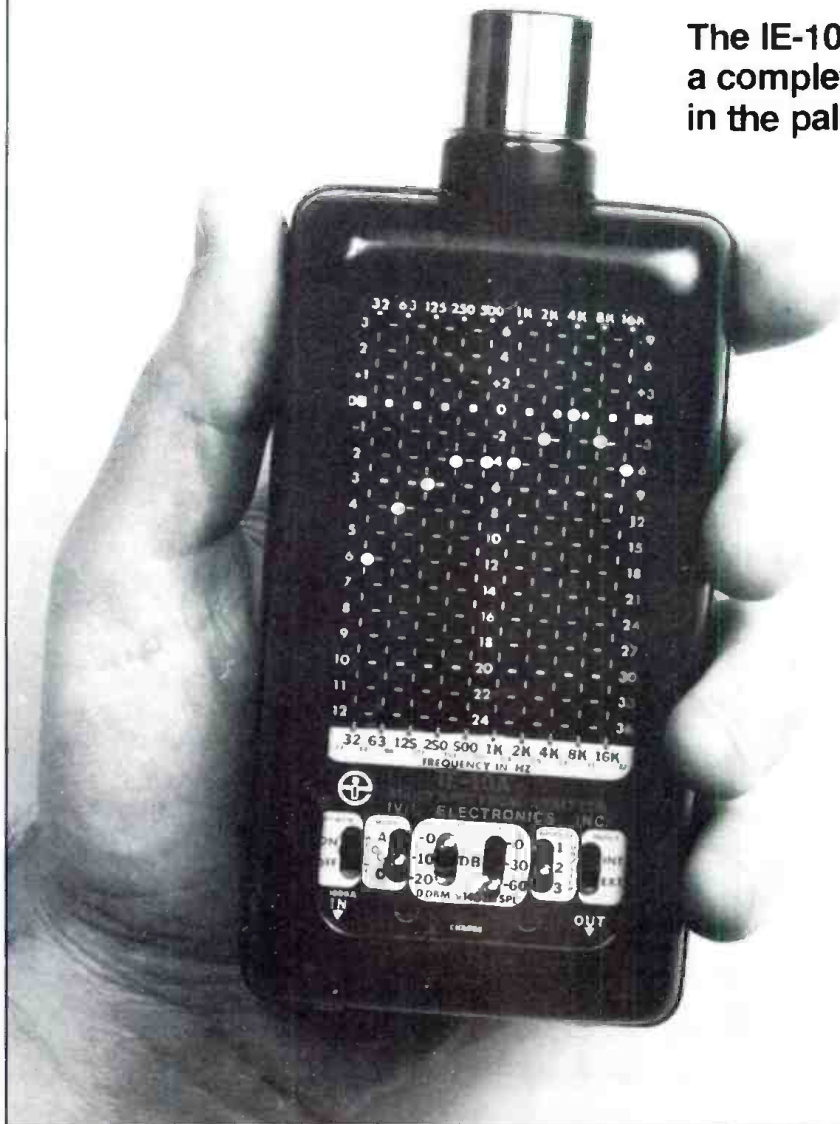

The Ivie family is growing with a powerful new set of accessories. Pictured above is the IE-20A Pink Noise Generator and the IE-15A Harmonic Distortion Analyzer is shown below.



## 3009+FD200

The FD200 is a new accessory from SME: a fluid damping device which can be fitted, easily and quickly, to any Series II or Series II Improved arm. The benefits of fluid damping have long been known: resistance to external shock, audibly improved bass, and reduction of spurious low frequencies; but these are not fully realised when the damping is applied at the bearings. For this reason the FD200 is designed to be fitted at a point along the length of the arm.

The FD200 design overcomes the usual problems of leakage and low efficiency. It offers a choice of three damping rates, to suit a wide range of cartridge compliances. The attractively presented kit includes viscous fluid and full instructions.

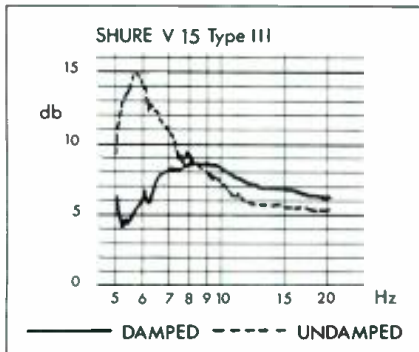

The illustration shows the extreme low frequency response characteristics of a typical high-quality cartridge in the Series II Improved arm.

Note the substantial reduction in the Q of the low frequency resonance. Although these frequencies are themselves outside the range of human hearing they give rise to undesirable side-effects which are audible.

Write to Dept 1843B, SME Limited  
Steyning, Sussex, BN4 3GY, England

Exclusive distributors for the U.S.:

Shure Brothers Incorporated  
222 Hartrey Avenue  
Evanston, Illinois 60204

and in Canada:

A. C. Simmonds and Sons Ltd  
975 Dillingham Road  
Pickering, Ontario, L1W 3B2

**SME**

# Stereo Monitoring and Measurements

● The stereo modulation monitor provides a considerable number of measurement functions in addition to its monitoring functions. But the stereo signal is more complicated than a monaural signal and requires more measurements to determine its overall quality. To produce accurate results, the monitor must be kept in good repair, calibrated, and correct procedures must be used in making the measurements. The instruction manual for the particular model will provide detailed instructions for the adjustments required for calibration, as well as procedures to use for measurements. We don't have space here to go into all the various procedures for specific models, but I will try to point out some of the important test areas and what the instrument measures at those times.

## METERING

Except for distortion measurements, most monitors can measure just about every important parameter needed to determine the system's transmission quality.

The monitor will contain at least two wideband, a.c. voltmeter sections. The inputs to these meters are on a selector switch so that the desired parameter to be measured can be selected. There will also be a sideband amplifier and a precision attenuator that is switched into the circuit path of the selected meter so that very small amplitude parameters can be measured with the meter section.

The panel meters themselves will have a scale similar to that of a vu meter or a modulation meter scale. This will be a 0-133 per cent range and a dB scale (the 100 per cent and zero dB coinciding). One of the meters will have another scale in percentage for measuring the pilot signal. The basic calibration is such that for a given internal voltage (according to the monitor's design), the meter will

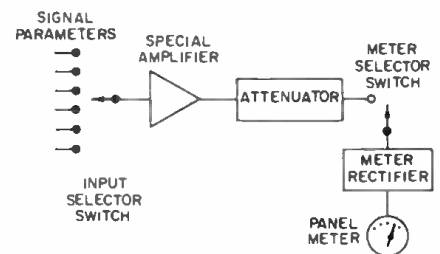

Figure 1. The metering section is a precision, wideband a.c. voltmeter.

indicate 100 per cent (zero dB). For measurement of low level parameters, the parameter voltage is amplified in a special amplifier and then attenuated with a precision attenuator. This raises the voltage to an amplitude that can be indicated on the meter and the calibrated attenuator and meter will then indicate the actual level in dBs.

During programming, both meters usually remain in the program's left and right audio channels so that the audio levels of these two channels can be continuously monitored.

## 38 kHz PHASING

Stereo monitoring functions and some of the measurement functions require current phasing for accurate results. This is due to the fact that the monitor reconstructs a 38 kHz subcarrier from the incoming 19 kHz pilot. Because the reconstructed subcarrier is used in the demodulation process for recovering the L-R audio information contained in the sidebands of the original subcarrier, the new subcarrier must have the same phase as the original subcarrier which it is replacing.

The 19 kHz pilot is derived from the original subcarrier's oscillator and thus has the same phase; theoretically

# Technological Leadership for 3 Decades!

Ampex, headquartered on the San Francisco Peninsula, is the company that "invented" the magnetic recording industry.

The technology pioneered by Ampex over three decades has affected many aspects of our modern lifestyles, and has established Ampex as a leader in magnetic recording. Our continued effort in developing new technology has always been the key to our leadership. Right now our Advanced Technology, Data Products and Audio-Video Systems Divisions are embarking on several new programs. To insure the success of these programs we are seeking innovative graduate engineers with experience in the fields listed below.

Opportunities like this don't happen very often. But they're happening at Ampex now.

## Advanced Technology Division

- electron beam and optical recording
- magnetic recording
- tape or film handling
- servos
- high-bit rate digital circuit design
- optics
- signal analysis
- pattern recognition
- high frequency circuit
- communications theory

## Data Products Division

- circuit/systems design of very high-bit rate systems

- disk read/write systems and equalizing systems for tape recorders
- codes for magnetic recording
- precision servo systems for both linear positioners and rotating systems
- mechanical design of high precision systems in disk recorders and in longitudinal, helical and transverse scan tape recorders

## Audio-Video Systems Division

- analog videotape signal systems
- digital video signal processing
- servo systems
- videotape editing
- professional audio recorders
- head technology
- TV cameras

If you think you have something valuable to offer in any of these or closely related areas, and if you would like to join some of America's most talented engineers, please send your resume or a letter outlining your qualifications to: Ampex Corporation, ATTN: Corporate Staffing Manager, Building 2, 2655 Bay Road, Redwood City, CA 94063. Or you can send us this coupon and we'll get back to you. We are an equal opportunity employer m/f.

**Manager Corporate Staffing  
AMPEX Corporation  
Building 2, 2655 Bay Road  
Redwood City, CA 94063**

Dept. 1

Name \_\_\_\_\_  
Address \_\_\_\_\_  
City, State, Zip \_\_\_\_\_  
Phone \_\_\_\_\_

Occupation \_\_\_\_\_  
Years of Experience \_\_\_\_\_  
Employer \_\_\_\_\_



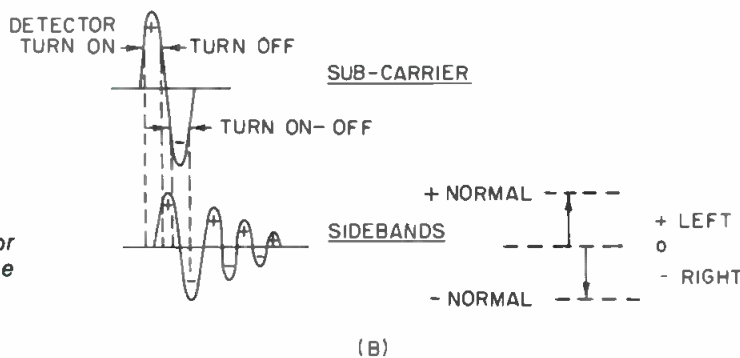
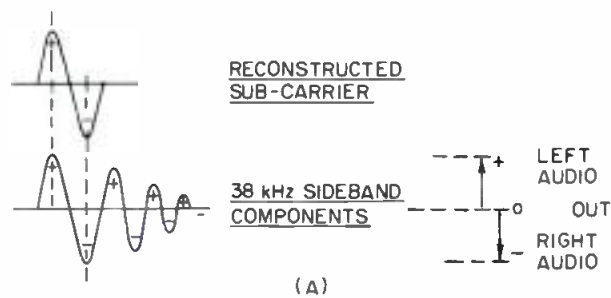

Figure 2. The reconstructed sub-carrier must be exactly in phase with the sideband signal or the results will be wrong. At (A) correct phase, at (B) incorrect phase.

the reconstructed 38 kHz subcarrier should have an identical phase as the pilot. Since in the reconstruction process there can be phase variances, the new subcarrier must have its phase adjusted to that of the pilot. Some monitors use a phase-lock loop for control of this phase. Others use a manual adjustment.

Since monitoring and measurement results rely upon correct phasing, the phase should be checked and verified during programming, and especially before making a series of measurements.

### PHASING AND SIDEBANDS

The phasing adjustment in the monitor adjusts the phase of the reconstructed 38 kHz subcarrier to that of the pilot. This assumes that the pilot still has the correct phase relationship to the sidebands as it did in the stereo generator. If anything should happen during the transmission to change this phase relationship, for example, a distorted bandpass, or a fault in the stereo generator, or misadjustment of the generator, then of course the new subcarrier will not have the correct phase relationship to the sidebands. This is one of those situations where the standard is not a true standard anymore. Whatever the reason, the reconstructed subcarrier must have the correct phase relationship to the sidebands—this is where the action takes place!

### PHASING ACTION

Correct phasing results in accurate recovery of the audio contained in the subcarrier sidebands. For functions requiring that audio, phasing *must* be accurate. Incorrect phasing will cause incorrect demodulation of the sideband audio. When this is matrixed with the SUM component, the left and right audio output signals will not be the same as they were when they went into the system.

Perfect phasing will align each cycle of the reconstructed subcarrier with each cycle of the sideband signal so that the peak of each of these signals will occur at exactly the same instant (and in correct polarity). Because the subcarrier amplitude will be many times greater than that of the sideband signal, it will control the action of the stereo detector. As the 38 kHz cycle goes in the positive direction, for example, the detector will begin to conduct as soon as this voltage reaches the forward conduction threshold, and it will remain in conduction until the subcarrier voltage drops below that point again. During this *on* time of the detector, sideband voltage will be allowed to pass to the

## STL Offers The Most Complete Selection Of Test Tapes Available Anywhere

If you are looking for precision test tapes, look no further. STL can serve all your needs with 150 mil cassette tapes, tapes in 1/4", 1/2", 1" and 2" sizes, flutter tapes and magnetic test films in Super-8 mm, 16 mm or 35 mm. STL gives you the most accurate reference possible in the widest range of formats. Order from us and find out where your system really is.

Write for a free brochure and the dealer in your area.

Distributed by Taber Manufacturing & Engineering Co.



STANDARD TAPE LABORATORY, Inc.

26120 Eden Landing Road / Suite 5  
Hayward, CA 94545  
(415) 786-3546

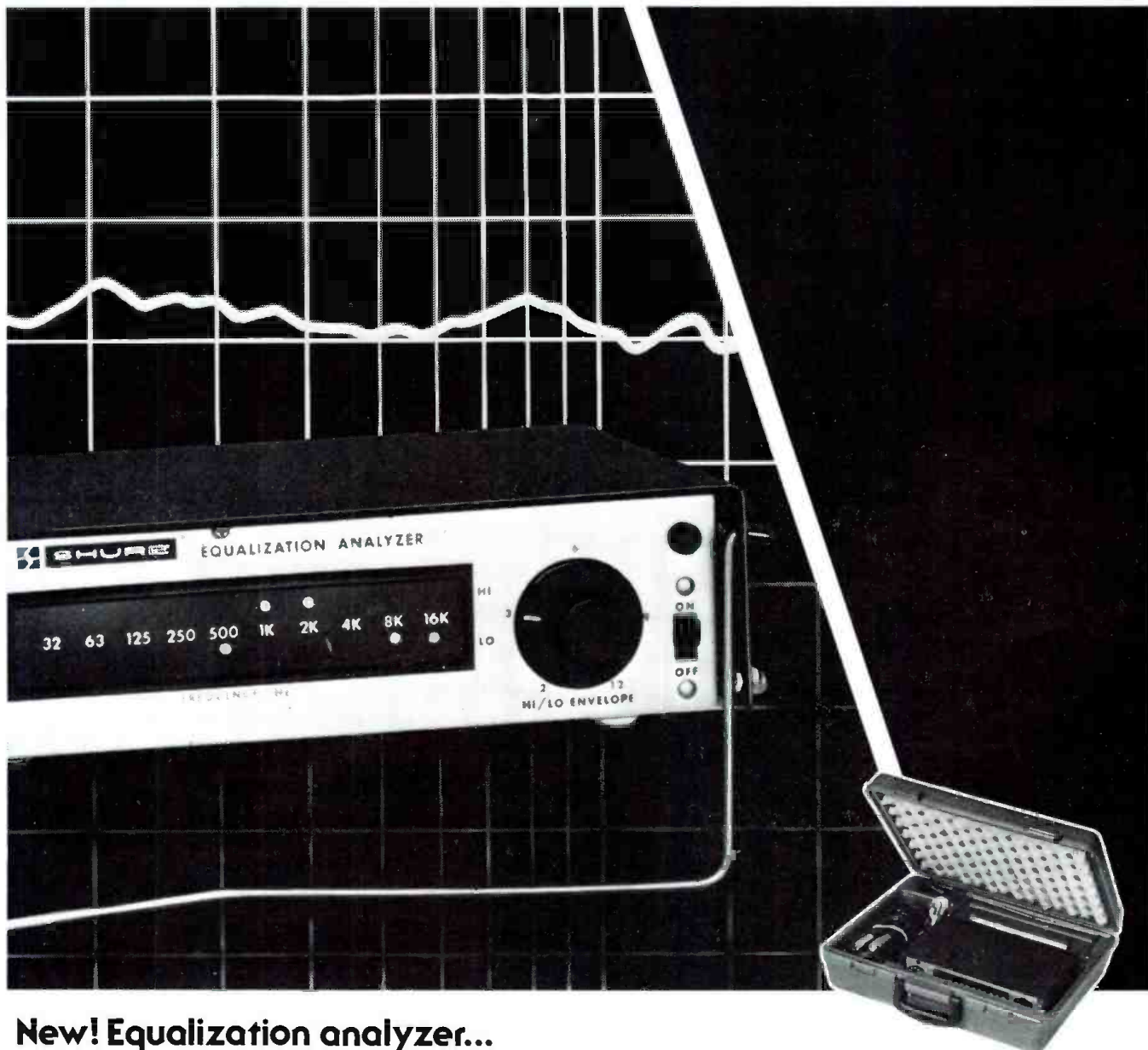

**New! Equalization analyzer...**

# Balance a system...Balance a budget.

Quick and accurate adjustment of sound system frequency response is finally within the reach of most budgets. The Shure M615AS Equalization Analyzer System is a revolutionary breakthrough that lets you "see" room response trouble spots in sound reinforcement and hi-fi systems—without bulky equipment, and at a fraction of the cost of conventional analyzers.

The portable, 11-pound system (which includes the analyzer, special microphone, accessories, and carrying case) puts an equal-energy-per-octave "pink noise" test signal into your sound

system. You place the microphone in the listening area and simply adjust the filters of an octave equalizer (such as the Shure SR107 or M610) until the M615 display indicates that each of 10 octaves are properly balanced. You can achieve accuracy within  $\pm 1$  dB, without having to "play it by ear."

Send for complete descriptive brochure AL558.

Shure Brothers Inc.  
222 Hartrey Ave.  
Evanston, IL 60204

In Canada:  
A. C. Simmonds & Sons Limited

#### TECHNICORNER

The M615 Analyzer's display contains 20 LEDs that indicate frequency response level in each of 10 octave bands from 32 Hz to 16,000 Hz. A rotary hi/lo envelope control adjusts the HI LED threshold relative to the LO LED threshold. At minimum setting, the resulting frequency response is correct within  $\pm 1$  dB. Includes input and microphone preamplifier overload LEDs. A front panel switch selects either flat or "house curve" equalization.

The ES615 Omnidirectional Analyzer Microphone (also available separately) is designed specifically for equalization analyzer systems.



MANUFACTURERS OF HIGH FIDELITY COMPONENTS, MICROPHONES, SOUND SYSTEMS AND RELATED CIRCUITRY.

Circle 14 on Reader Service Card

www.americanradiohistory.com

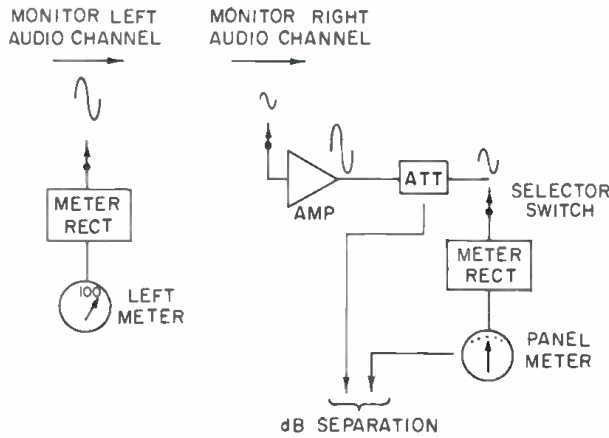

Figure 3. Meters read the ratio of the voltage amplitudes in both audio channels for separation measurements. (Shown is left-to-right separation.)

detector's output ports. The actual peak amplitude of this sideband voltage depends upon where the sideband cycle is in relation to the phase of the subcarrier cycle. If the 38 kHz leads or lags the phase of the sideband, conduction will be either on the up slope or the down slope of the sideband cycle. Therefore, the actual peak voltage reached in the detector output circuit depends upon the sideband amplitude at this point in time—it will be less than the sideband true peak value. If the 38 kHz should lead or lag by 180 degrees, the positive

half-cycle would cause the detector to conduct on the negative half-cycle of the sideband, reversing the left and the right output audio channels!

### SEPARATION

An important measurement of the system is the separation of the left and right audio channels. Perfect separation requires that each of these channels retain its identity throughout the system. If there is audio in one channel, then ideally none of that audio should appear in the other channel. But no system is perfect and some

of the audio in one channel will find its way into the other channel by various means. The monitor will measure the residual audio in one audio channel that belongs in the other channel. But the monitor cannot measure separation with program signal since both audio channels are active and there would also be no reference.

In the normal measurement procedure, an audio sine wave is fed to one channel of the stereo generator and the other channel remains idle. The level of this signal is the normal full channel input level and the composite signal will modulate the f.m. carrier to 100 per cent. If the audio is fed to the left channel for example, then the left channel meter on the monitor will indicate to 100 percent (zero dB), and the right meter will indicate nothing. Since the separation measurement is a ratio of the audio signals that now appear in both channels, the audio in the left channel (in this case) must be at the zero dB (100 per cent) level. The amplitude of the residual signal appearing in the right audio channel will then be so many dB below this left channel level.

Now that the unit is set up to measure the separation, the special amplifier/attenuator is switched into the right circuit path so that the right meter can now indicate the actual dB level of this residual signal. The meter and the attenuator will then provide a direct reading in dBs of the left-to-right channel separation. To measure separation in the other direction, that is, right-to-left, the right audio channel is fed tone and the metering switched to indicate the residual in the left channel caused by the right channel audio.

Accurate separation measurements depend upon an accurately calibrated monitor. Before making a series of measurements, the monitor's own separation should be checked out and calibrated according to the instructions in the instruction manual. The internal separation in today's monitors is something like 70 dB.

### CROSSTALK

Crosstalk in the stereo measurement sense is the measurement of signal components that appear in the main channel (0-15 kHz band) or in the sub-channel region (23-53 kHz band) when there is modulation of one or the other area separately. In programming, of course, both of these two areas of the composite signal are active and modulating the f.m. carrier, but for measurement purposes, only one area is activated at a time while the other area is measured. To cause this to happen requires the correct input to the stereo generator. To ob-

## OCTAVE BAND ANALYZER

### THE NEW MODEL 150

#### FEATURES

Simultaneous display - TEN one octave bands—31.5 Hz to 16 kHz  
 • Light Emitting Diode readout • Meets ANSI 1.11, Class II for Octave Band Filter Sets • Fully calibrated in dBspl • Broadband dBspl • Line Input—calibrated in dBm • Flat or A-weighted measurements • Hand held—battery operated (rechargeable nickel-cadmium cells) • Precision microphone, carrying case, noise generator, battery charger included



#### APPLICATIONS

- Sound system set-up
- Noise surveys
- Octave equalizer adjustment
- Speaker checkout
- Horn alignment
- Room surveys and speaker placement

ALSO: Active and passive equalizers • Other real time analyzers  
 Dealer inquiries invited

*White*

Call or write today: WHITE INSTRUMENTS, INC.  
 P.O. BOX 698 512/892-0752 Austin, Texas 78767

Circle 26 on Reader Service Card



At first glance our cabinets look a little different. Which is understandable. They are.

It's quite plain that these are not your usual assortment of little flake-board boxes with holes. These are functioning enclosures whose dimensions, determined by the laws of physics, have been precisely stated in hand-laminated fiberglass.

All of our enclosures are of a solid round-backed design which frees them from the standing waves and out of phase diaphragmatic panels which plague "the boxes". Our design not only cuts down on unwanted resonances but also creates unparalleled durability and the strength to survive extensive touring and triumph over playful roadies. The GGM, our dual

driver ported bass enclosure, fills a variety of functions. As the bottom end of a PA stack it makes a dynamite low frequency cabinet. Pre-amped and powered it becomes a bass guitar cabinet the likes of which you've never heard. The PBL,

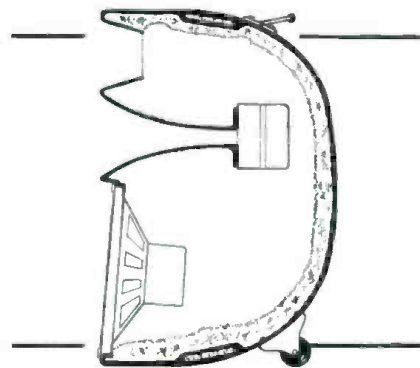

our full-range super portable cabinet, incorporates bass, port and HF horn in one rugged enclosure. Perfect for club PA applications, this unparalleled (literally!) cabinet is perfect for keyboards and other instruments and also happens to be a fantastic side fill stage monitor. And our NC12? Only the loudest, cleanest monitor around. And everything you need to hear is aimed right at your face. Write or call us for more information. It's time you got the best.

|       | HF DRIVER               | LF DRIVER |
|-------|-------------------------|-----------|
| NC 12 | 1" - 1 3/8"             | 12"       |
| PBL   | 1" - 1 3/8" - 2" - 2.8" | 15"       |
| GGM   | n.a.                    | TWO 15"   |

# Here's Looking at You, Kid!

# Community

Community Light & Sound Inc., 5701 Grays Avenue, Philadelphia PA 19143 (215) 727-0900

Circle 28 on Reader Service Card

www.americanradiohistory.com

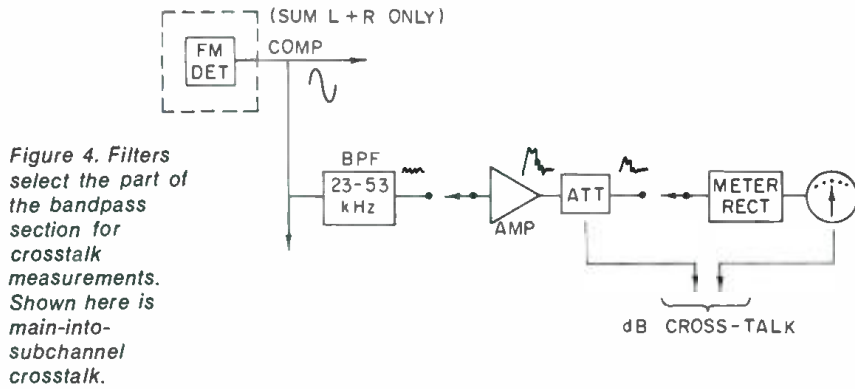

Figure 4. Filters select the part of the bandpass section for crosstalk measurements. Shown here is main-into-subchannel crosstalk.

tain main-channel-only modulation, the audio to the left and right inputs of the stereo generator must be in-phase sine waves. The output of the generator will then be only a SUM audio signal—with no sub-carrier sidebands at all. To obtain sub-channel modulation, the audio must be fed to both inputs of the stereo generator out-of-phase. The output then is only that of sub-carrier sidebands, with no SUM signal.

Whichever measurement is to be made, with the appropriate input to the stereo generator, for example, the main channel, the sub-channel area of

the spectrum is passed by an accurate filter and any signal components present are measured by the metering circuit in dBs. This is crosstalk main into sub-channel. For sub into main, the other condition is set up and the audio band is selected by an accurate low-pass filter, fed to the metering circuit, and measured in a similar manner.

High or out-of-tolerance crosstalk measurements can be caused by the filters in the monitor, filters in the stereo generator, or by harmonics and intermodulation components caused by non-linear operation somewhere in the system.

### 38 kHz SUPPRESSION

The carrier in a.m. modulation contains no intelligence information, and in our stereo multiplex, the carrier is suppressed. This conserves the modulation capability of the f.m. carrier. Any subcarrier that is present in the composite signal will add to the amplitude of that signal and thus would require reducing the f.m. carrier modulation. If, for example, there is a fault or misadjustment in the stereo generator so that 10 per cent of the composite signal is subcarrier, to prevent overmodulating the f.m. carrier, the modulation must be reduced 10 per cent (1 dB). We have already lost 10 per cent to the pilot and if sca is in use, another 10 per cent. This would leave only 70 per cent of

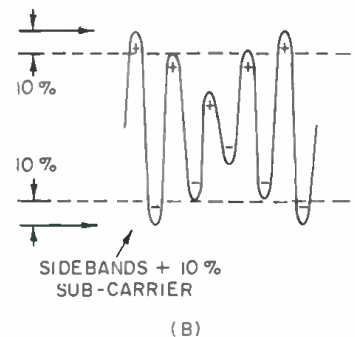
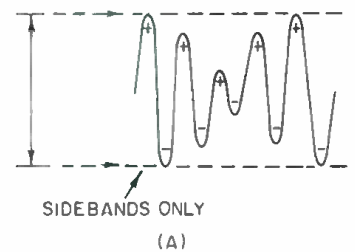

Figure 5. Any signal of the original sub-carrier that is not suppressed will add to the amplitude of the composite signal. (10 per cent shown here.) At (A) normal carrier suppression is shown while at (B) can be seen 10 per cent of sub carrier in the signal.

the modulation to our audio signal, and signal-to-noise in the audio suffers. A narrow 38 kHz pass filter will direct any incoming 38 kHz to the metering section for measurement. This must be down at least 40 dB.

### SUMMARY

The stereo monitor offers many test capabilities as well as monitoring facilities. By learning how the particular monitor operates and what it is measuring, the station engineer will find the monitor very helpful in defining problems and make troubleshooting and corrections easier. ■

Circle 35 on Reader Service Card ➔

# THE CUE MACHINE

If our intercom systems can handle the Academy Awards, the Grammy Awards and the Montreal Olympics, imagine what they'll do for your productions!

**A Free package of possibilities is yours for the asking**

**Clear-Com**<sup>®</sup>

intercom systems

759 Harrison St., San Francisco, CA 94107

(415) 989-1130

Circle 31 on Reader Service Card



# SAE Power

SAE's goal today, just as it has been for over 12 years, is the design and production of fine audio components which offer the best value in both sonic performance and quality construction. Our line of amplifiers stand as a testament to this goal.

First, their design — all SAE amplifiers have fully complimentary circuitry. In this unique design approach, not only the output (as in conventional amplifiers), but the drive and input stages, are completely complimentary. This ensures low transient and steady-state distortion, plus full stability and fast overload recovery. Combine this with our high slew rate for accurate transient response, feedback gain controls which will not degridate the input signal (2600, 2400L), and monocoque construction with its low weight and high reliability (2200, 2400L).

The result is state-of-the-art performance, but to realize this performance we must have the second part of our goal — production. In order to ensure optimum performance from these unique design concepts, SAE retains total control over the manufacture, selection, and assembly processes. We maintain 40,000 sq. ft. of production area where the latest techniques in metal and circuit board fabrication, component selection and product assembly are employed. The result of these efforts is the line of high quality amplifiers pictured here, each an outstanding value in its power range and each a true SAE component where performance and value come together — that's SAE Power!

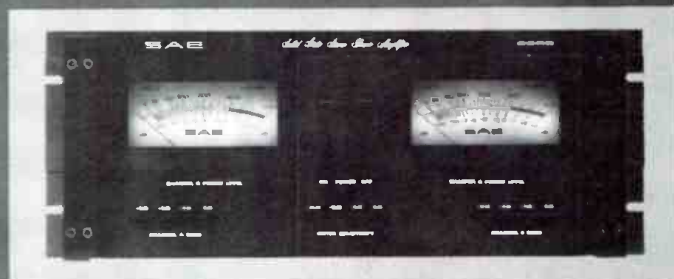

2600 - 400 Watts\* — our most powerful amplifier, designed for high power home environments. The 2600 ensures clean, dynamic reproduction at the highest power levels.

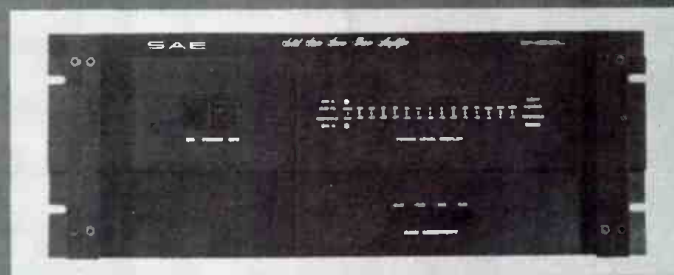

2400L - 200 Watts\* — combining performance and reliability in a surprisingly compact package. This amplifier can reproduce the most demanding program material without strain.



2200 - 100 Watts\* — Incorporating our advanced circuitry and technology, the 2200 offers high levels of clarity and definition at a popular power level.

\* All power ratings are per FTC requirements and are stated with the following parameters: 20Hz to 20kHz, from 250 mW to rated power with less than 0.05% Total Harmonic or Intermodulation distortion.

**SAE**  
Scientific Audio Electronics, Inc.

P.O. Box 60271 Terminal Annex, Los Angeles, CA 90060

## Use of Analogs: part 2

● Last month I left you with a problem that is a useful half-way introduction to the use of analogs. I finished up showing you the physical dimensions that determine leakage inductance between windings, without considering how you will represent such an inductance in a schematic. This is where it gets into a kind of analog situation.

I did point out something that has been argued from time to time, that leakage inductance is highly linear because it is effectively an "air-cored" inductance even on an iron-cored transformer, unless you go to the trouble of inserting magnetic material in the leakage path—which is unusual but has been done.

FIGURE 3 of last month's article indicated that most winding spaces are longer than they are deep. FIGURE 1 repeats that sketch, with an additional one to illustrate the point. If the space occupied by the windings is approximately three times as long as it is deep and if it is totally occupied by two windings, a primary and a secondary, what will be the comparative leakage inductances between the two windings, arranged in the alternative manners shown?

Because the roles of the dimensions identified as  $L_1$  and  $D$  are interchanged, the leakage inductance, assuming the same number of turns in each arrangement will be approximately nine times the value, in the arrangement on the right, of that on the left. And, like the primary form of inductance, its value is proportional to the square on the number of turns in the winding.

Suppose one winding has 1,000 turns, and the other one has 1,500 turns, what does that mean? All right, suppose that, in the arrangement on the left, the leakage inductance referred to the 1,000-turn winding is 10 millihenries. Then, referred to the 1,500-turn winding, it will be 1.5 squared, or 2.25 times this, which is 22.5 millihenries.

Now, going to the arrangement at the right, referred to the 1,000-turn winding, the leakage inductance will

be nine times the value, or 90 millihenries. Referred to the 1500-turn winding, it will be 202.5 millihenries.

### CAPACITOR ACROSS THE WINDING

Next, as a step toward designing the filter I introduced at the end of last month's column, what would be the effect of connecting a capacitor across the 1,500-turn winding, say a 0.01 microfarad value? This depends on where you look at the circuit. Let us take the arrangement on the right because that most nearly corresponds with the arrangement we shall use to design the filter.

A capacitor of 0.01 microfarad will tune an inductance of 202.5 millihenries to about 3,500 hertz. Looked at through the transformer, the capacitor will have its reactance divided by 2.25 or its capacitance value multiplied by 2.25 to look like a value of 0.0225 from the 1000-turn side. So from that side, it looks like 90 millihenries with 0.0225 microfarad, which also tunes to about 3,500 hertz.

FIGURE 2 shows how the circuit will look with external impedance components. On the secondary, or 1,500-turn side, the capacitor is in parallel with any other load impedance connected. But on the primary, or 1,000-turn side,

the leakage inductance and capacitance are in series.

This means that if the impedance on the 1,000-turn side is very low in value, and the impedance on the 1,500-turn side is very high except for the 0.01 microfarad capacitor, the equivalent circuit looks like a series-resonant circuit from the 1,000-turn side and a parallel-resonant circuit from the 1,500-turn side. The Q-value of the resonance will increase by making the impedance on the 1,000-turn side lower and by making the impedance on the 1,500-turn side higher.

The fact is that this arrangement can act as a resonant, as well as an ordinary, transformer in the same package. The "operative impedance" of the resonant transformer will be  $\sqrt{L/C}$ , which figures to 2,000 ohms on the 1,000-turn side, or 4,500 ohms on the 1,500-turn side. What this means is that at the resonant frequency, putting 200 ohms on the primary will look like 45,000 ohms on the secondary, or vice versa.

At that frequency, a 200-ohm resistance on the 1,000-turn side will provide a maximum-energy transfer match for a 45,000-ohm resistance on the 1,500-turn side. Change the resistance on the 1,500-turn side to 22,500 ohms, half the previous value, and the matching resistor on the 1,000-turn side will be double the previous value, or 400 ohms.

### BUILDING A FILTER

When building the filter shown at FIGURE 3, which was mentioned at the end of last month's column, each of the inductors can be a leakage inductance. FIGURE 4 shows a possible physical configuration in cross-section. The first inductance,  $L_1$  in FIGURE 3, can be the leakage inductance between section A and section B of FIGURE 4. The second inductance,  $L_2$  in

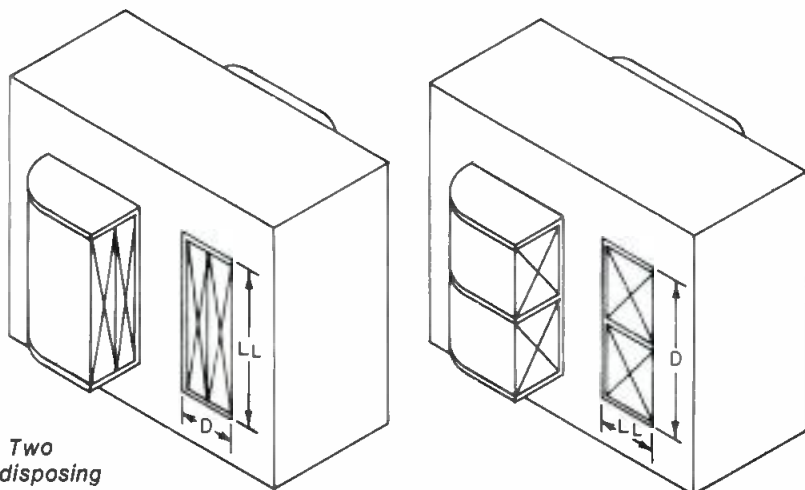

Figure 1. Two ways of disposing of leakage inductance within a transformer winding.



Broken strings  
Lost plectrums  
Ripped skins  
Limp stands  
Pipless maraccas  
Crackling leads

At least you don't have to worry about the mixer.

Soundcraft Series 1.

World's first road mixer built into a strong metal flight case. Turn it off, shut the lid, throw it in the back of the truck. It'll work perfectly tomorrow. And tomorrow and tomorrow, for years to come.

12 into 2 or 16 into 2. Three mixes; main stereo, monitor and echo. Each input channel has variable line/mic attenuation, 4-band equalisation, peak level LED indicator, echo and monitor (foldback), pan, mute and pfl.

Each output has 2-band equalisation, (so does the monitor master) and the illuminated VU meters show master, monitor or pfl. THD < 0.1% Max mic gain 70dB. Relative input noise -125dBm. Multicore cable and stage box also available.

Soundcraft Electronics Limited 5-8 Great Sutton Street  
London EC1V 0BX England Telephone 01-251 3631  
Telex 21198 Telegrams Soundcraft LDN EC1

Soundcraft North America Division  
P.O. Box 883 JFK Station Jamaica New York 11430 USA  
Telephone (212) 528 8158 Telex 01-2203

**SOUNDCRAFT**  
ELECTRONICS LIMITED

Circle 19 on Reader Service Card

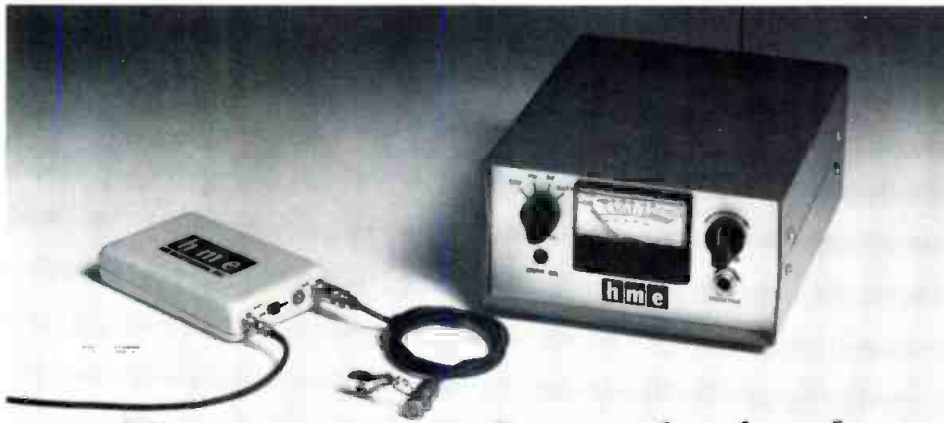

## The new name for professional RF wireless microphones

Only the name is new. You will recognize the picture as the same field proven system that has gained universal acceptance in the industry under the label of the leading professional microphone manufacturer. But now this fine product is available from the people who engineered and built it: HM Electronics, Inc.

The System 22 is HME's top-of-the-line VHF Hi Band wireless microphone intended for

**h m e**

HM ELECTRONICS INC.

use by professionals. Critical adjustments can be made by the audio engineer such as soft compression,

transmitter power (can be switched to legal maximum), and internally supplied power for Electret microphones.

To learn more about the System 22 or our new executive and universal lines call or write HM Electronics, Inc. 6151 Fairmount Avenue, San Diego, Ca. 92120 Ph. (714) 280-6050

Circle 18 on Reader Service Card

## Take a Waters slim-line space-saver

New MM thin-line faders are great for small portable mixers or lighting consoles. Only half the width of conventional faders, our 3/4-inch wide MM series lets you build a lot of mixing or control capability into a limited space. No performance compromise, either. You get Waters' proprietary MystR<sup>®</sup> conductive plastic resistance elements. Glass-hard. Smooth. Long-lasting. You get Waters' computer-controlled curve shaping for highest tracking accuracy. And, you can choose 2 3/4-inch or 4-inch travel; 600 ohm or 10,000 ohm impedance; linear, audio, or true log characteristic. For complete information, circle the reader service card, or call Bob Waters at 617-358-2777

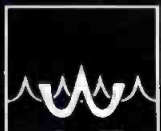

**WATERS MANUFACTURING, INC.**  
LONGFELLOW CENTER, WAYLAND, MA 01778

Circle 15 on Reader Service Card

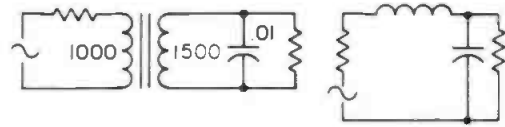

Figure 2. Circuit and equivalent circuit of leakage inductance, tuned with a capacitance.

FIGURE 3, can be the leakage inductance between section B and section C of FIGURE 4.

So across section C you connect capacitor  $C_1$ . One advantage of this kind of design is that you make the turns in section C suitable for using some convenient standard value for  $C_1$ , just as the 1,000 to 1,500 turns ratio transformed the effective value of the capacitor connected across the second winding. Nothing but the capacitor is connected across section C.

Now, the relative widths of spaces A and C in conjunction with the one common to both, section B, determine the relative values of  $L_1$  and  $L_2$ . In practice what you do to design this part of the circuit is to arrange spaces A, B and C, so that the leakage inductances are in the ratio determined by the theoretical design. You then pick the number of turns on section A to suit the designed input impedance and the number of turns on section C to suit the capacitor value you intend to use as standard.

Now we have two inductors and a capacitor of the filter. Winding B provides the output point for connecting to the other elements, for which we use spaces D, E, and F, which have to be equal in their total to the total of A, B, and C, as a matter of physical convenience.

We make the spaces D, E, and F to suit the ratio between the remaining two inductances. D to E, making  $L_3$  and E to F, making  $L_4$ . Now what we have to do is make the two sets fit. As sections A, B, and C are on a different core limb from sections D, E, and F, windings B and D may need to have different numbers of turns. The coupling is achieved by connecting the two windings together.

The difference in the number of turns will arrange that the total space  $A + B + C$  is equal to the total space  $D + E + F$  when the relationship between inductances  $L_1$  and  $L_2$ , and  $L_3$

Figure 3. The filter circuit for which leakage inductance is to be used. (See text to find out how values are realized.)

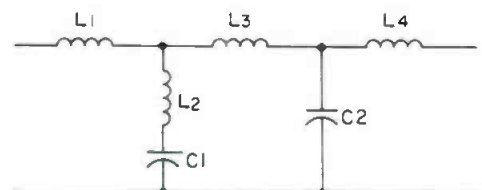

# Another Limiter?

So ask the cynics. That's why we made the Orban/Parasound 418A special. It's a stereo compressor/limiter/high-frequency limiter system that compresses the dynamic range of complex program material with astonishing subtlety and freedom from side-effects. It simultaneously and independently controls the high frequency energy to protect preemphasized media (like disc, cassette, and optical film) from high frequency overload distortion. It's cleaner than most linear amplifiers (THD at 1 kHz is typically 0.02% for any degree of gain reduction), and stereo tracking is locked-in for life without adjustments.

The 418A is highly "smart" and automatic. There are only three controls that affect the sound quality. This means that the 418A can speed the process for budget-conscious customers (like commercial producers) and bring them back again and again. The 418A is also ideal in the broadcast production studio ahead of the cart recorder, where it guarantees clean carts, free from over-

load and high frequency saturation due to excessive EQ.

The recording studio can use the 418A to generate master tapes which will transfer to disc and cassette gracefully and cleanly. The subtle, dynamic high frequency control means that high frequency equalization can be used more freely than ever before without danger of overload. The cassette duplicator and optical film recorder can condition problem masters to maximize signal-to-noise and eliminate high frequency splatter in these touchy and demanding media.

The Orban/Parasound 418A isn't "just another limiter"—it's a time-saving system that handles chores ordinary limiters can't touch. It's available at your Orban/Parasound dealer.

**orban/parasound**

680 Beach Street, San Francisco, CA 94109 (415) 673-4544

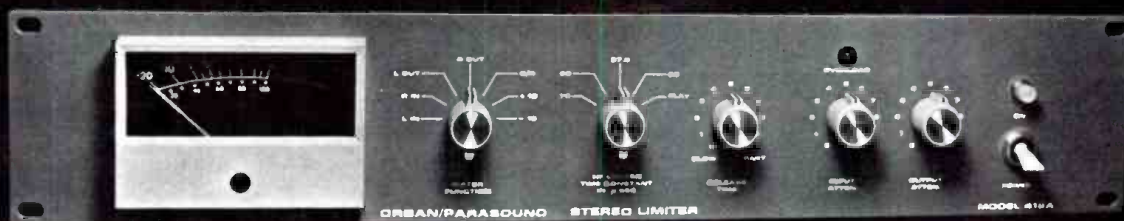

Circle 20 on Reader Service Card

## Divide and conquer.



Conquer distortion, defeat clipping, clean up your mix.

Bi-amplified on or tri-amplification with Yamaha's F-1030 frequency-dividing network can take you a long way down the road to audio perfection.

By separating high, mid and low frequencies before amplification, the F-1030 increases efficiency and headroom to the point where you need fewer amplifiers and speakers to produce the same sound level. What's more, by dividing the sound for several amplifiers and many sets of speakers, the F-1030 eliminates the cost of individual passive crossovers.

**Control your own!** Unlike other dividing networks, Yamaha's F-1030 offers dB-calibrated detented controls on both inputs and outputs, as well as transformer-coupled XLR and standard phone jack connectors. Twelve selectable crossover frequencies range from 250Hz to 8kHz, with your choice of 12dB/octave or 18dB/octave slopes, plus a switchable 40Hz 12dB/octave high-pass filter.

**Use with confidence!** Noise and distortion are virtually extinct. The Yamaha F-1030 will drive a full +24dBm (12.3 volt) output into a 600 ohm load. It will also accept input levels to +30dB.

There's just not enough room here to give you the whole story. So send this ad along with three dollars. (Please, certified check or money order only. No cash or personal checks.) We'll rush you the F-1030 operation manual. Or better yet, see your Yamaha dealer.



Musical Instrument / Combo Division  
6600 Orangethorpe Avenue,  
Buena Park, CA 90620.  
Write: P.O. Box 6600, Buena Park, CA 90622

Circle 22 on Reader Service Card

www.americanradiohistory.com

and  $L_1$ , is satisfied. The turns on space E are designed to suit the standard capacitor used for  $C_2$  in the same way used for section C.

At this point we have a complete filter which will match any convenient values of capacitor, to the required design values, and will also match different input and output impedances, something that is not possible with any other way of constructing this kind of low pass filter.

## REVIEW

If you are not sure how that worked, go over it again carefully. The relationship between the first two inductors is fixed by the relative spaces, A, B, and C. Their effective value is fixed by the turns used on A. The relationship between the second two inductors is fixed by the relative spaces, D, E, and F. Their effective value is fixed by the turns in D, relative to the turns in B. Any sets of turns in the correct ratio, which will not usually be far from equal, will serve here, just changing the voltage at which the transfer is made. For example, if the required ratio proves to be 1.15, you could use 1,000 turns on B and 1.150 turns on D, or 2,000 turns on B with 2,300 turns on D equally well.

Finally, the relationship between the effective values of the capacitors, and the value actually used can be adjusted by the number of turns wound in spaces C and E while the output impedance can be adjusted by changing the turns of F.

This is a very interesting design procedure, and provides intriguing possibilities as a practical matter for iso-

lation of the various circuits, not possible with any ordinary low pass filter.

## TWO TRANSFORMERS

Where is the trick, you may be asking? Well, of course, any transformer also performs a high-pass function as well as a low-pass function. This is really two transformers, using a common core. Because you use two legs of the same core, each leg will have its own primary inductance, and thus you have two inductances that I have not talked about so far.

These inductances have magnetic cores, which the leakage inductances we have been talking about do not. If they should saturate anywhere in the pass band, below the low-pass cut-off frequency, they could introduce distortion. Or if, in conjunction with the circuit impedances, these inductances produce a high-pass action or low-frequency loss within the desired pass band, that could detract from your intended performance.

So you really do not get something for nothing. But the use of leakage inductances, which have physically controlled values based on the dimensions of the structure, are highly stable, and possess considerably better Q values than simple air-cored types, can be quite attractive. By being inside the core, although using air spaces, they are effectively shielded from outside fields, which air-cored inductors are not, unless you put them in a shielding can, which both changes their values and downgrades their Q.

Candidly, I believe the only reason that leakage inductance has not been used more in equipment design is that few engineers have figured out how to put it to use, rather than having to "fight" it as a source of high frequency losses. ■

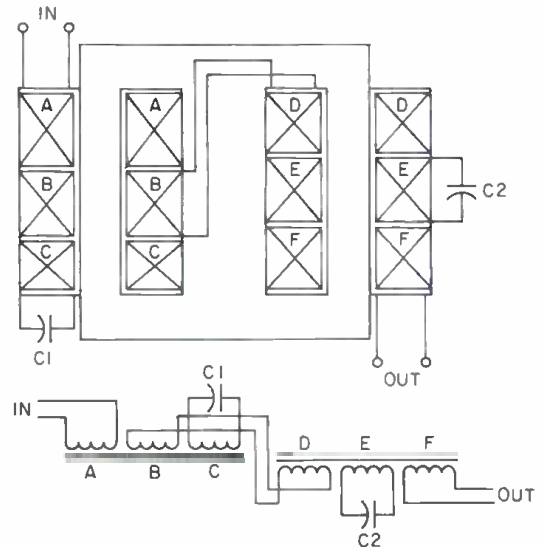

Figure 4. Physical configuration of windings to achieve a filter circuit.

**the better source**  
**for pro audio systems and equipment**

31 major lines in stock at all times with nearly \$1 million inventory for immediate delivery. For competent, courteous New England service at New York prices, call (617) 926-6100 weekdays 10 to 9; Saturdays 10 to 5.

**K & L PRO AUDIO**  
 K & L Pro Audio  
 75 North Beacon Street  
 Watertown, Massachusetts 02172

Introducing

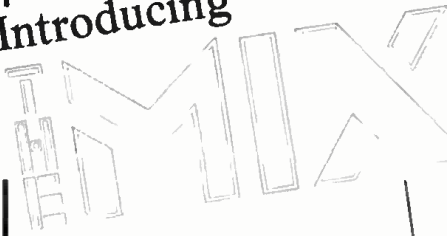

## Northern California Edition

Catch it  
in the **MIX**

*THE MIX—the first comprehensive directory of commercial recording studios and services. Northern California edition.*

*THE MIX—will provide a reference guide for professional and semi-professional recording studios and their clients.*

*THE MIX—over 100 studios [4 track and up] profiled in depth with a complete and detailed description of pertinent information.*

*THE MIX—includes location, owners, engineers, dimensions of control room and studio, number of tracks, types of tape recorders, mixing consoles, monitor amps and speakers, outboard equipment, microphones, instruments available, extra facilities, rates, credits, history and direction.*

*THE MIX is being published with the cooperation and sponsorship of some of the people who make it all happen in the Bay Area Music Scene: Guitar Showcase, NARAS, Sound Genesis, HUN Sound, Bananas at Large, Recording Specialities, David Rubinson and Different Fur.*

**A BAM Magazine Publication**

*Southern California edition available soon.*

Send for your special bound edition today.  
Please send     copies of THE MIX at  
\$5.00 +\$1.25 postage & handling.

Name \_\_\_\_\_

Company Name \_\_\_\_\_

Address \_\_\_\_\_

City \_\_\_\_\_

State \_\_\_\_\_ Zip \_\_\_\_\_

Allow 2-4 weeks for delivery.  
Send to: The Mix Magazine  
PO Box 6395  
Berkeley, Ca 94706

**Sound Workshop will introduce  
its new 16 Track Recording Console  
at the Audio Engineering Society Convention  
in New York City  
on November 4th, 5th, 6th, and 7th.**

**We suggest you check it out.**

**Sound Workshop**  
PROFESSIONAL AUDIO PRODUCTS

bringing the technology  
within everyone's reach.

Sound Workshop Professional Audio Products, Inc., 1040 Northern Blvd., Roslyn, New York 11576 (516)-621-6710

# Audio Tape for professionals



## REEL TO REEL TAPE

Ampex, 3M. All grades,  
On reels or hubs.

## CASSETTES, C-10—C-90,

with Agfa, Ampex, 3M Tape

## LEADER & SPLICING TAPE

## EMPTY REELS & BOXES

All widths, sizes.

— COMPETITIVE • FROM STOCK —



Recording Supply Co.

1233 Rand Road  
Des Plaines, IL 60016  
312/297-0955

Div of  
Polyline Corp.

Circle 36 on Reader Service Card



**MEASURE  
REVERB TIME  
IN REAL TIME.  
Instantly!**

## RT-60.

This easy-to-use  
instrument delivers pre-

precise reverb time measurement in instant real time digital read-out. No more chart recorder or time-consuming chart recorder analysis. The RT-60's integrated circuitry incorporates a one-third octave band pass filter system with frequency centers on 250, 500, 1000, 2,000, and 4,000 Hz. It operates on self-contained ni-cad batteries. Mounted in a rugged carrying case, the RT-60 weighs only 3.5 pounds. The dealer net cost, FOB San Diego, is just

**\$460.**

Write for your free technical  
bulletin on the RT-60 — instantly!

**COMMUNICATIONS  
COMPANY  
INC.**

3490 Noell Street  
San Diego, CA 92110  
Telephone (714) 297-3261



Circle 32 on Reader Service Card

JOHN M. WORAM

# db The Sync Track

## Quad Sound and Docket 21310

● If you've dropped into your local hi-fi emporium lately, you may have discovered that inquiries about quadriphonic sound are about as welcome as killer bees. I may be overreacting, but it seems that the hardware retailer takes great delight in doing what he can to destroy whatever market there is for quad. Since I'm involved (as a consultant) in the quad scene, I hear countless tales of would-be customers being turned off by negative remarks from the sales people.

Now although this magazine is presumably not identified as a hi-fi book, we're all involved in hi-fi sooner or later. After all, that's what the dB (and db) is eventually all about, isn't it?

In the recording business, most of us take stereo for granted, and plan our recordings in terms of an eventual left-to-right speaker placement. But if and when quad sound firmly establishes itself, we shall find ourselves recording and mixing for four speakers instead of two. Will we one day take quad for granted too?

Assuming the ideal quad system exists, the creative possibilities are obvious. Ambience-type recordings create a sense of spaciousness that is only hinted at in stereo. Surround-sound recordings give the pop group a creative tool that will keep an imaginative producer busy for hours. (Just think of the studio rentals!)

But meanwhile, back at the hi-fi shop, the salesman is doing his best to steer the customer away from quad. The hardware manufacturer is slowing up his quad production line, because of poor sales. Likewise, the record manufacturer, who complains that quad records don't sell very well. (Ironically, the handful of stores that are aggressively promoting quad seem to be doing quite well. The big complaint is that they can't get enough hardware and software to keep up with the demand!)

Mr. Average Record Buyer is con-

fused. There are several systems competing for his attention. But who buys records according to "the system"? Most of us buy them because of the music, and if the competitive rivalry means that our favorite artists are spread out over two or three different systems, we're apt to get discouraged, and stick with good old safe stereo.

Presumably, once quad gets "off the ground" the compatibility problems will be solved in the marketplace. In the meantime, the same folks who used to say that "mono's all we really need" are now piously chronicling the death of quad. One hopes that this backward-looking mentality will eventually die by itself, but in the meantime, quad sound is having a rough go of it.

## THE FEDERAL COMMUNICATIONS COMMISSION

And now, enter the FCC. According to a recent news release, "The Commission has begun an inquiry on whether to adopt standards for FM quadriphonic radio broadcasting.

"The Commission said the purpose of its inquiry was to determine whether there was sufficient public and industry interest to warrant adoption of standards for quadriphonic broadcasting, and, if so, to develop a record that would assist the FCC in formulating standards.

"The Commission urged radio equipment manufacturers, broadcasters, and the listening public to make known their interests and to contribute relevant information to assist it in this proceeding."

What does this mean to the average db reader? Let's assume that most of us are not radio equipment manufacturers or owners of broadcasting stations. (How's that for a safe bet?) But most of us are members of the listening public, and we have a more-than-routine interest in high-quality sound. If a good quadriphonic broadcasting system was available, we'd listen to it:



if good quad records were easy to find, we'd buy them. And, if quad recording techniques became widespread, we'd begin doing our own quad sessions.

If you go along with this, it's time to get out a piece of paper and let the FCC know of your interest. If you (the listening public) can convince them (the Commission) that quad sound deserves to be heard, we may live to see the end of this period of quadriphonic confusion, and the beginning of a healthy market for four channel hardware and software.

The inquiry before the FCC is known as Docket 21310, and your comments should be addressed to:

Docket 21310  
Federal Communications  
Commission  
1919 M Street, N.W.  
Washington, D.C. 20554

Let the FCC know that you are interested in f.m. quadriphonic broadcasting, and that you will do what you can to support it, once a standard has been published. If you are ready to buy quad hardware, by all means let them know. (Relax, no salesman will call.)

You have a chance to influence the future of f.m. broadcasting, and of the entire quad recording industry. And your letter will be effective. The FCC wants to know how you feel, so don't waste the opportunity. After all, when was the last time the feds asked you for advice? Of course, if you still feel that mono is all we really need, please disregard this notice.

By the way, if you're already hooked on quad, and are having trouble locating records, there's a mail-order house that specializes in quadriphonic records and tapes. Write to Sound Concepts, P.O. Box 654, Peoria, Illinois 61652 and ask for Catalog 771.

And for more information on specialized quad systems, the following addresses may come in handy:

**SQ Matrix System**  
CBS Technology Center  
227 High Ridge Road  
Stamford, CT 06905

**QS Matrix System**  
201 Communications, Inc.  
201 East 42nd Street  
New York, NY 10017

**CD-4 Discrete System**  
CD-4 Forum  
45 Lakeside Drive  
Rockville Centre, NY  
Rockville Centre, NY 11570

And while you've got your pen out, don't overlook db Magazine. We're planning a quad update issue, and your comments would be most welcome. ■

**BTX 4500**  
synchronizes  
recorders for \$3,850

BTX new synchronizer sync, any two ing sensible

4500 SMPTE edit code sync will bring into sync, and hold in video or multi-track audio recorders using SMPTE time code.

Use this completely self-contained system to sync your VTR to your audio recorder, or to expand the number of audio tracks with two multi-track recorders in tandem.

For complete information call The BTX Corporation, 438 Boston Post Road, Weston, Massachusetts 02193 (617) 891-1239.

btx

Circle 21 on Reader Service Card



## What's cooking?

**IC Op-Amp Cookbook** by Walter G. Jung. Explains basic theory of the IC op amp in a down-to-earth manner. Includes over 250 practical circuit applications. Fully illustrated and designed for all interested in modern linear IC design techniques. Covers general operating procedures, such as offset nulling, frequency compensation, and protection against abuses and failures; signal-processing circuits; audio circuits including low-level preamps, active filters and equalization circuits, power-booster stages up to 100 watts, and a variety of other specialized circuits. Includes unique devices that cannot be categorized with standard types—programmable op amps, operational transconductance amplifiers, quad current-differencing amplifiers, etc. **\$12.95**

**SAGAMORE PUBLISHING CO., INC.**  
1120 Old Country Road,  
Plainview, N.Y. 11803

Please send \_\_\_ copies of **IC Op-Amp Cookbook** at \$12.95. N.Y.S. residents add 8% sales tax.

Name \_\_\_\_\_

Address \_\_\_\_\_

City \_\_\_\_\_

State/Zip \_\_\_\_\_

**616 - 452 - 1596**  
**Your Direct Line To**  
**PROFESSIONAL**  
**AUDIO**  
**EQUIPMENT**

We represent, stock, sell,  
and service only the best

... such names as ...

- Audiotronics
- Ampex
- Beyer
- Cetec
- Crown
- DBX
- Eddcor
- Electro-Voice
- Editall
- Fidelipac
- LPB
- Marti
- Micro-Track
- Nagra
- Neumann
- Nortronics
- Pulse Dynamics
- Ramko
- Revox
- Russco
- Scully
- Sennheiser
- Shure
- Sony
- Soundcraftsman
- Spotmaster
- Switchcraft
- TEAC
- Tascam
- UREI



**Audio Distributors, Inc.**  
2342 S. Division Avenue  
Grand Rapids, Mich. 49507

Trades Welcome  
Anything That Doesn't Eat  
Lease Plans Available

Circle 34 on Reader Service Card

## A Look At Some New A/V Devices

● It happens often that people start doing something, then are side-tracked in the middle to something else, and possibly move to still a third direction. This occurred recently during a project with which I was involved and resulted in this view of a couple of audio/visual

devices with which you may not be familiar.

A synchronized slide program was prepared in New York and sent to another city where the cassette would play the audio track as well as the cues to trigger the slide advance action on a Kodak carousel projector. The original programming was done on a Model 2550 Wollensak cassette recorder. The total system and program were the simplest arrangement possible for a single-screen automatic show.

In the out-of-town location, the person who would set up the show was told to rent a Model 2550 unit, or a 2551, which is the later version of the machine. For those unfamiliar with these particular recorders, the 2550 has one track for the audio and a second track for the "beeps" which activate the forward motion of the projector. The tones are put on the tape by a button on the recorder; at each point in the program where a slide movement is to take place, the button is pressed and the cue is put on the tape. The signals can be erased, re-recorded, and changed during the show without necessarily having to do the entire program's synchronization over, although this can certainly be done if desired.

The 2551 was made to operate with the cues put on tape by the 2550, but also had a button on it to put its own tones on a tape. The signals put on by the 2551 were 1 kHz, while the ones from the 2550 were of a lower frequency. Therefore, the newer machine was made with a switch on the side to permit the user to go from the narrow frequency position to "broadband."

which would allow the 2550 signals to operate satisfactorily. However, tapes cued on a 2551 could not be used on a 2550. The audio portion was fine, of course, but the automatic signals would not operate the cue electronics in the older unit.

### THE MISSING SWITCH

When the client in the other city set up the equipment to play the tape, the sound was okay, but the slides would not move. In checking with New York, it was found that the cable hookup was right, the projector worked fine by itself, and the "beep" switch on the top of the machine was in the play position. (This switch has three positions—*off*, to prevent cues on the tape from activating the slides whenever a pause is desired; *play*, the normal position for proper operation; and *record*, which puts the original cues on the tape.) It was then suggested that the switch on the side of the 2551 was in the wrong position, and should be moved to "broadband;" otherwise the cues from the 2550 would not work. It was then learned that this particular unit did not have the switch mentioned although it was most definitely the Model 2551. A second 2551 was brought in. Same results. No 2550 was available, so a production person from N.Y. was sent to the city with the original 2550. Success! Everything went well.

This incident led to a bit of an investigation on why the 2551 did not have the broadband switch, and the answer was rather simple. When the 2551 was first made, it did have a switch on the side. It turned out that there was a second model made after

**maxell**

---

**FOR REEL  
QUALITY**

---



LOGGING LENGTHS AVAILABLE

**ASK US!**

**AUDIO SALES LTD.**

FULL LINE DISTRIBUTOR  
FOR AUDIO RECORDING

1370 Avenue of the Americas  
New York N.Y. 10019 212) 581 6950

Circle 23 on Reader Service Card

the first one, and the original was not being made anymore. The newer Model 2551 would not work with the cues from the 2550, but did operate with the signals from the original 2551. This now meant that people with the 2550 tape had to carry their own 2550 unit with them, or be sure they could get a model exactly like it wherever they were going in order to be able to use the tape. They could use the 2551, if they were sure it was the *old* 2551 (with the *broadband* switch) not the *new*. Most equipment rental firms like to get the newest units available for stock whenever they can, and rightly so, but here is a situation about which the user must be aware. It seems, therefore, essential that the companies which rent these units should inform clients who request one of these machines just what the situation is regarding the overlap of models. It can only create good will when one is helpful.

### NEW PROGRAMMING DEVICES

This experience led to an interest in other models made by Wollensak, some of which are new and others that might be unfamiliar to you. At a demonstration by Reliance Audio Visual Corp. of some new Wollensak programming devices, Charles Spataro, vice president for sales and rentals, led the Reliance team at the presentation. Representatives of the 3M Company Mincom Division were also present. The showing introduced a cued cassette which triggered a new programmer, through dissolvers, to twelve slide projectors on six screens—actually a single screen with six images, three wide horizontally and two high. Each screen had two projectors in dissolve to change the images.

Many of the units made by Wollensak in the slide synchronization field were on display, and literature was available for some not being shown. For example, 3M makes Models 2548 and 2558. Both consist of a unit like the 2551, mounted in an attache-like suitcase with space for a slide projector, and with a speaker in the cover. The 2548 is a recorder, while the 2558 is a player only. Both have the same specs as the 2551 (without the recording capability in the 2558) and both operate on the 1,000 Hz. signal. The 2548 (like the 2551) has both separate output and input for audio and the cue tones which allows for complete duplication of programmed cassettes.

Then there are Models 2556 and the 2561. (Incidentally, all these model numbers are followed by the letters AV to indicate the visual applications for synchronization with slides or film-

strip projectors.) These two models are players only. The 2561 is portable (like the 2551). Both 2556 and 2561 come with separate outputs for sync and external speakers. Both are listed as heavy duty. Another difference between the 2556 and the 2561 is that the latter has inputs for hi-level or mic audio. Thus, the unit can be used for public address in either the *stop* or playback mode; the mic is live in both positions. This allows for separate commentary even while the program tape is going.

Then there are the 2570 and 2575. The former is portable, and is also a recorder. The latter is a deck only for playback. Both units respond to the 1,000 Hz signal for slide advance, but also have an additional signal feature—a 150 Hz cue will stop the machines automatically. This tone can be put on by pressing a *stop-restart* button on the 2570 during cue recording. In order to restart the machines, there is a provision for a remote program restart hand or foot control. These controls can also stop the machine and then restart them remotely. Separate sync and audio outputs permit complete cassette duplication of audio and cue simultaneously. (The 2568 has a 2570 version in a luggage-style suitcase with a speaker in the lid and space for a slide projector.)

### MODELS 2573 AND 2590

Models 2573 and 2590 incorporate more sophisticated features than any of the others. The former (called *Sync II*) includes the standard 1000 Hz tone for slide advance and the 150 Hz for automatic stop, but has the added feature of also being able to control a second slide projector or dissolve unit with the lower frequency tone.

This is accomplished by a button located between the Sync I (1000 Hz) and Sync II (150). When this button is left in the normal *up* position, the 150 Hz signal will act as a stop. When the *mode selector* is depressed, the 150 Hz signal acts a second cue for projector activation. Another capability of the machine with its two sync pulses is possible with the use of a special cable and the Wollensak AV-33 dissolver. Using Sync I alone will cause a single speed of dissolve. A second speed is possible with Sync II alone. When Sync I and Sync II are used together, a third speed becomes available. Thus, dissolve action can be either slow, medium, or fast, and can be programmed on the tape that way. There is also a vu meter for audio level control.

The 2590 also has three buttons for sync operation, but they operate dif-

ferently. A 150 Hz signal will stop the machine and a 1000 Hz tone will advance the slides, but a *review* button permits checking preceding visuals as far back as desired, in complete sync with the tape. Thus, depressing the *review* button momentarily brings back the previous slide and also the proper audio. Keeping the button down returns the slides shown previously as far back as desired. When the button is released, whether held momentarily or kept down, the tape will automatically start again in sync with the slide being shown at the point the button was released. Both the 2573 and the 2590 have separate sync and audio outputs and inputs, and both are recorders. There is also a 2595 model which is a player only.

### MICRO-PRO 40

The newest item in the line is the Micro-Pro 40 Multi-Image Memory Programmer, the star of the presentation. Many people may be familiar with previous programmers in the line, the Digi-Cue Pro-6Q and the Pro-9Q, in which the digits indicate the number of available channels of the units. The latest model has 40—32 momentary and 8 latching. The memory system provides for 1929 steps, all of which can be transferred to tape in seconds and verified for accuracy before putting on the master with the audio. Programming is not required to be done in real time (as it is done on the audio cassette recorders discussed) and all changes can be made easily at any time. A numeric and l.e.d. display board shows the operating mode, (the cue and frame being looked at, the selected time intervals chosen for action (from 0.025 to 5 seconds in 8 steps or any combination of them), and the entry/output display as well as latching channel status.

Please be aware that this review of the items does in no way indicate preference over any other unit or any other manufacturer. It is strictly intended as an indication of the equipment available, and is meant to illustrate how easy it is to be led from investigation of one point into a variety of other paths—and the interesting things that can be learned. In subsequent discussions on this type of equipment, other manufacturers will be examined thoroughly. The equipment described will include dissolvers, power control units, etc. This will all lead to a column on multi-images and their applications—good and bad. If there are any special subjects you wish to see discussed here, just write. I promise to reach each and every suggestion, and follow through, if possible. ■

# db New Products & Services

## REINFORCEMENT/RECORDING CONSOLE

● Incorporating features applicable to both sound reinforcement and recording, stereo mixing console Model 1202 has balanced Lo-Z and unbalanced Hi-Z mic connections on each input channel, in addition to line level signals for multi-track recording. Three-band eq. (bass, mid, and treble) with  $\pm 15$  dB range is included on each channel. Pre/post capability is included for the effects, reverb, and monitor send controls. Stereo pan and channel volume controls are also included, as well as variable gain control on the mic pre-amp used in conjunction with the l.e.d. peak indicator. Equalization provision includes five-band eq. on the monitor output and bass and treble controls giving reverb return eq. on the mains. There is headphone volume and source select monitoring, an auxiliary input on each main, balanced outputs on mains and monitor, and l.e.d. metering arrays.

*Mfr: Tangent Systems, Inc.*

*Circle 51 on Reader Service Card*



## COMPACT LOUDSPEAKERS



● Twin loudspeakers, SR112 and SR116 have identical characteristics but differ in design for varied usage. SR-112 is designed for permanent installation indoors, with weather protection for limited outdoor use. SR116 is a portable unit with a carrying handle. The speakers have the capacity to produce a sound pressure level of 95.5 dB (at 4 ft.) with an input power of one watt, providing a full range frequency response over a range of 45 Hz to 16,000 Hz without frequency-correcting equalizers. They are designed to operate with high power amplifiers delivering up to 100 watts of continuous power to an 8-ohm load. The units each use two heavy-duty eight-inch bass speakers and a high compression driver coupled to a 120 degree radial horn. Low frequency performance comes through the front-ported bass reflex design of the enclosure.

*Mfr: Shure Bros.*

*Price: SR112: \$340, SR116: \$384.*

*Circle 52 on Reader Service Card*

## A COMPLETE CONSULTATION



### WORAM AUDIO ASSOCIATES

Consultants in Studio Systems  
Engineering, Design and Installation

—offering—

SERVICE FOR STUDIO  
PLANNING AND  
CONSTRUCTION

FREE-LANCE RECORDING  
SERVICE IN THE  
NEW YORK AREA

516 764-8900  
45 Lakeside Dr.  
Rockville Centre, N.Y. 11570

## DIRECT INPUT PREAMPLIFIER



● Direct input for low output moving coil cartridges, with no transformer or preamps required, is significant in the design of RAM200 preamplifier. All inputs look into f.e.t.s for low noise, high impedance, non-reactive inputs. All output circuits are class A complementary bipolar transistors. Range is 2 Hz to 80 kHz  $\pm 0.5$  dB at any level control setting. RIAA equalization is 30 Hz to 15 kHz  $\pm 0.2$  dB. Two phono inputs with programmable resistive and capacitive loading allow optimizing of the loading of phono cartridges. HI and LO filters are 3-pole active with 18 dB per octave slopes. There is a built-in 1 watt-per-channel headphone amplifier, automatic or manual muting, a 36-position attenuator switch, and a dual l.e.d. output level indicator, with 46 dB range.

*Mfr: Ram Audio Systems*

*Price: \$1,000.00.*

*Circle 53 on Reader Service Card*

## OSCILLATOR/FREQUENCY COUNTER



● Combined low distortion oscillator and digital frequency counter Model CB9109 handles 10 Hz to 100 kHz in four push button ranges, with eight pre-set frequencies from 10 Hz to 20 kHz. A push button output attenuator in 10 dB steps gives a 70 dB range, plus fine control and mute button. The frequency counter, which has a separate input accessible on the front panel, gives continual display of oscillator output frequency in both sine and square modes. The timing period is selected by the frequency range push buttons.

*Mfr: Trident Audio Developments Ltd.*

*Price: \$507.00 (Approx)*

*Circle 54 on Reader Service Card*

## PROGRAMMABLE MIXER

● Centralized control of the mixing functions is possible with this computerized mixer. Designed to incorporate the techniques of numeric coding, memorization, switching, and attenuation, the mixer memorizes pre-mixed programs, assists manual mixing and display, and complements existing installations. The mixer carries out the first mixing level before proceeding to a traditional console, centrally extending the number of input channels in operation, actually controlled through fewer channels by the operator. The mixer offers 12 inputs comprising pre-amplification, overload indicator, and attenuator; 4 groups of outputs; one pre-listen. In programming, there are 15 different memorizations of all the data for each of the 12 input channels, with the capacity of storing the contents of these memories on a digital cassette, and permanent visual indication of its state on a display terminal. The design includes a control panel enabling conversation with the operator; a rack containing the electronics; a digital cassette for recording/reproducing; a crt display terminal.

*Mfr: Compteurs Schlumberger*  
*Circle 55 on Reader Service Card*

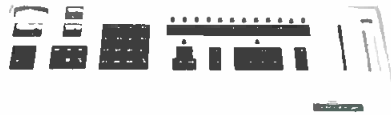

## DIRECT BOX



● It is possible to record directly from the amplifier or pickup of an electronic instrument with direct box DBP 1100. Input and instrument jacks are muted to permit simultaneous recording and amplifier function. The box can sit on rubber feet on any flat surface or snap onto a mic or music stand with clamps. Input impedances are 20 Hz to 15 kHz, greater than 50k ohms; 1 kHz to 5 kHz greater than 100k ohms. The ground on/ground lift switch connects the chassis grounds of the console to the guitar or guitar amp. If the signal source is an amp itself, a pick up/amp is provided. High frequency compensation to simulate the response of a typical guitar or amplifier speaker is provided with a filter/flat which goes into operation when the pick up/amp switch is in the "amp" position.

*Mfr: Westlake Audio*  
*Circle 57 on Reader Service Card*

## STEREO HEADPHONES



● There are six passive radiators in each earpiece of K-240 stereo headphones. The relationship between the driver and the passive radiators is such that the radiators are activated by sound-pressure waves produced by the active driver. At frequencies above 200 Hz the radiators are acoustically transparent, eliminating mid- and high-frequency cavity self-resonances. At frequencies below 200 Hz the complying radiators provide bass response without boominess.

*Mfr: AKG (Philips Audio Video Systems Corp.)*  
*Circle 56 on Reader Service Card*

# Wipe tapes clean in record time.



## Garner Erasers

provide clean erasures in only four seconds—with no noise residue. Tapes are wiped cleaner than new. Our simple, safe, continuous belt operation handles all sizes of reels, cartridges and cassettes from 10½" on down.

**Garner Erasers** are now fulfilling the exacting requirements of many major organizations around the world... yet are so low priced that the smallest studio or station can afford one.

### User reports...

"It is a big improvement over what we used to use, or anything else on the market today."

—*Ric Hammond*  
*KNX Radio (CBS)*  
*Hollywood, Calif.*



Call today. Or write for  
 a brochure and names of users  
**GARNER INDUSTRIES**  
 4200 N. 48th St., Lincoln, NE 68504  
 Phone: 402-464-5911

*Circle 24 on Reader Service Card*

**MODULAR MIXER**

● Solid state audio mixer Model 1100 fits into a standard electronic equipment rack. The line/mic mixer will accept six line or six microphone inputs and has a monaural output. The unit has a monitor capability, high and low frequency equalization, and a vu meter. The inputs and the program output are transformer isolated. Claimed s/n ratios are: microphone input, 78 dB  $\pm$  1 dB and line input, 80 dB minimum. Maximum continuous sine wave power is + 24 dBm  $\pm$  0.5 dB. Equalization is  $\pm$  20 dB at 20 Hz and 20 kHz and  $\pm$  14 dB at 100 Hz and 10 kHz.

*Mfr: Spectra Sonics*  
*Price: \$800.00.*

*Circle 58 on Reader Service Card*



**MIXER EXPANDER**



● Designed to complement Series Model 5 mixer. 5EX expander can increase the inputs from eight to as many as twenty. The extension unit is equipped with eight 201 input modules. An additional four inputs are optionally available. The expander retains all the functions of the Model 5 mixer, such as four line output busses, a cue output bus, echo output bus, and a solo output.

*Mfr: TEAC Corporation*  
*Price: Under \$1,300.*

*Circle 61 on Reader Service Card*

**SPEAKER/PAGER**

● Portable KB-111P has all electronics mounted within a handled steel enclosure, including a 4 in. all-weather speaker and 2 watt amplifier module. The unit contains a combination call/speaker mute switch. Both the portable and the standard wall-mounted (KB-111) speakers have XLR-type connectors, front panel mounted, which fit the manufacturer's handsets and headsets. KB-111P also includes XLR-type connectors side-mounted for input/output looping. Two-conductor shielded cable wires the speakers to remote or main stations. Signal-to-noise ratio of better than 55 dB is claimed.

*Mfr: Clear Com*  
*Circle 59 on Reader Service Card*



**MUSIC-RECORDING CONSOLE**



**MINIATURE THREE-WAY SPEAKER**

● Uniform musical dispersion at all frequencies, with in-depth reproduction of instrumental individuality is claimed for miniature L 300 stereo three-way speaker. The driver complement consists of a 5 1/8 in. long excursion woofer, a special dome mid-range and a linear tweeter that extends the high frequency response to 25,000 Hz. A computer designed crossover network minimizes phase anomalies and assures equal energy output over the entire musical spectrum. Economy of space is achieved by mounting the tweeter coaxially with the woofer, but physical isolation of the individual drivers is maintained. The little unit weighs only 13 1/4 lbs. and slips inconspicuously into cramped areas.

*Mfr: Braun A. G.*  
*Price: \$398 pair*  
*Circle 60 on Reader Service Card*



■ Expandable Types A and B Eclipse studio consoles are designed specifically for multi-channel music recording. The units are available as 4-, 8-, 16-, 24- and 32-track systems with up to 40 input. Custom choice of equalizers offers a wide assortment, all of which are interchangeable, including two styles of graphic. Features include solo in stereo position with echo; monitor echo; two pannable effects returns; two programmable mutes on each input; patching using professional size 1/4 in. jacks; illuminated color-coded channel selectors; stereo cue system; light beam level displays available optionally.

*Mfr: Sphere Electronics*  
*Circle 62 on Reader Service Card*

# John Woram's The Recording Studio Handbook

FOR RECORDING ENGINEERS,  
TECHNICIANS AND AUDIOPHILES

The technique of creative sound recording has never been more complex than it is today. The proliferation of new devices and techniques require the recording engineer to operate on a level of creativity somewhere between a technical superman and a virtuoso knob-twirler. This is a difficult and challenging road. But John Woram's new book will chart the way.

*The Recording Studio Handbook* is an indispensable guide. It is the audio industry's first complete handbook that deals with every important aspect of recording technology.

Here are the eighteen chapters:

- The Decibel
- Sound
- Microphone Design
- Microphone Technique
- Loudspeakers
- Echo and Reverberation
- Equalizers
- Compressors, Limiters and Expanders
- Flanging and Phasing
- Tape and Tape Recorder Fundamentals
- Magnetic Recording Tape
- The Tape Recorder
- Tape Recorder Alignment
- Noise and Noise Reduction Principles
- Studio Noise Reduction Systems
- The Modern Recording Studio Console
- The Recording Session
- The Mixdown Session

In addition, there is a 36-page glossary, a bibliography and five other valuable appendices.

John Woram is the former Eastern vice president of the Audio Engineering Society, and was a recording engineer at RCA and Chief Engineer at Vanguard Recording Society. He is now president of Woram Audio Associates.

This hard cover text has been selected by several universities for their audio training programs. With 496 pages and hundreds of illustrations, photographs and drawings, it is an absolutely indispensable tool for anyone interested in the current state of the recording art.

Use the coupon at the right to order your copy of *The Recording Studio Handbook*. The price is only \$35.00, sent to you with a 15-day money-back guarantee.

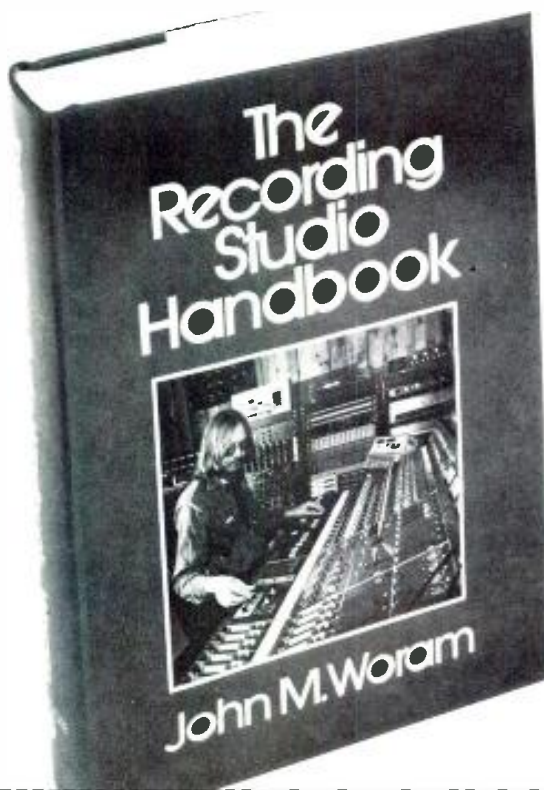

SAGAMORE PUBLISHING COMPANY, INC.  
1120 Old Country Road, Plainview, N.Y. 11803

Yes! Please send \_\_\_ copies of *The Recording Studio Handbook* at \$35.00 each. On 15-day approval.

Name \_\_\_\_\_

Address \_\_\_\_\_

City/State/Zip \_\_\_\_\_

Total Amount \_\_\_\_\_

N.Y.S. Residents add appropriate sales tax \_\_\_\_\_

Enclosed in payment for \$ \_\_\_\_\_  
Outside U.S.A. add \$2.00 for postage

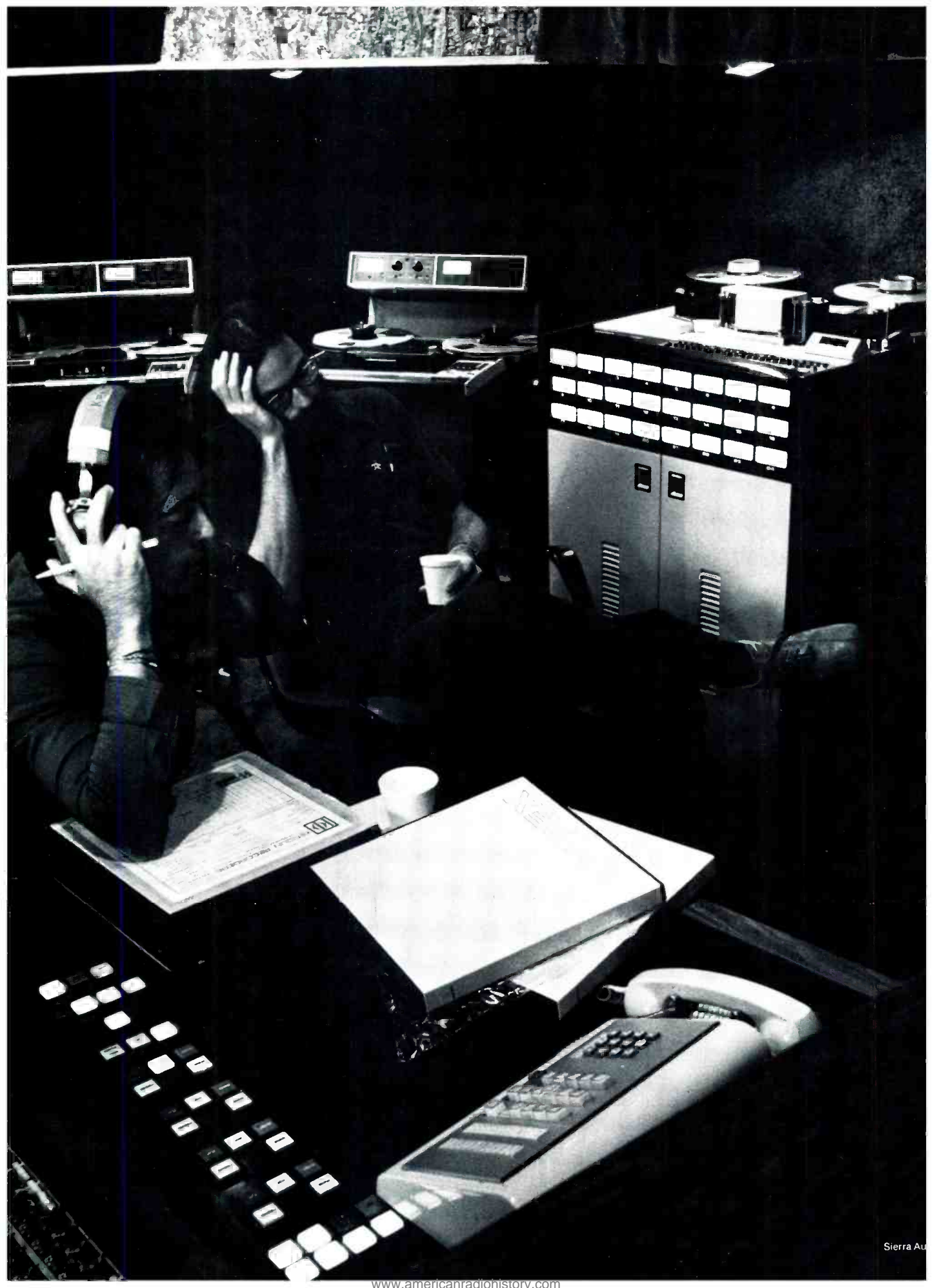



# Sometime before the sun comes up, you'll learn to love your MM-1200.

Ampex gives you a lot of reasons to buy an MM-1200 multichannel audio recorder: capacity, fidelity, flexibility and reliability. The performance specifications alone have made this the best seller among professional multitrack recorders.

But you'll find your own reasons for loving the MM-1200 you buy.

Some morning, after a night of sessions that dragged through the wee hours, you're going to realize just how many MM-1200 features you used to keep things moving. How you used the electronic tape timer, plus search-to-cue, to save precious minutes of time. How you used the quick-change

head feature to switch back and forth between 8, 16 and 24 track work. The ease with which you employed the optional accessories such as the pure video layback head, synchronizer and variable speed oscillator to finish the audio portion of a video production.

The same professional drive for perfection that kept *you* going, kept *our* engineers working to refine an already-respected design.

That's why you see so many MM-1200s in professional recording studios. Sooner or later, before the sun comes up, everybody learns to love an MM-1200.



## AMPEX

# The Equalization Myth

*Balanced room ambience, a time decay situation, cannot be achieved by patchwork equalization.*

**M**ONITOR SYSTEM equalization is the most widely used method of compensating for control room acoustical faults. With a real-time analyzer (rta), the equalization process is fast, simple, and cheap. Unfortunately, it is also wrong, because it overlooks the basic physical factors through which rooms affect the sound of a loudspeaker.

Imagine a room with smooth, hard, totally reflective surfaces. A sound introduced into this room would never die away; it would just keep bouncing around forever. In an anechoic chamber, however, sound is absorbed almost instantly (as soon as it hits the first highly absorptive surface). These two rooms represent acoustical extremes—in real rooms sound absorption takes a finite time. This time varies for different frequencies. A carpet-lined room absorbs high frequencies quickly but the low frequencies are absorbed much more slowly. The way these reverberation times, or  $T_{60}$ s, change at different frequencies is what distinguishes one room's sound from another's. ( $T_{60}$  is defined as the interval in which sound pressure decreases by 60 dB after a steady-state sound has been abruptly shut off.)

## FREQUENCY-DEPENDENT $T_{60}$

How do these frequency-dependent  $T_{60}$ s affect the loudspeaker's sound? First the sound emerging from the loudspeaker reaches your ears directly. The sound then hits a surface which absorbs part of its energy, in relation to the absorption curve of the surface material. A plywood panel will absorb more energy from the low frequencies than it will from the high frequencies that impinge upon it. The carpeted room mentioned before has just the opposite effect, absorbing high frequencies. A number of reflections multiply this absorption characteristic many times and after the direct sound has passed, our ears still hear the frequency-modified reverberation.

In the carpeted room we are left with a muddy sound, since the high-frequencies were absorbed quickly. FIGURE 1 shows the result in a heavily carpeted room. The initial sound consisted of two tones of a low and a high frequency of equal volume. In the balanced room this sound has decayed to a faithful miniaturization of the original, but the heavily carpeted room has eaten up the highs and changed the spectrum from that of the original sound. Note that the high frequency wiggles are gone. We are left with a decayed low-frequency note only, hence the term "muddy sound." If you don't want a muddy reverberation, you must treat the room with materials that absorb low frequencies as quickly as high frequencies. If we had been listening to music, our ears would have heard the new notes, plus the muddy reverberation of past notes, giving the impression of added bass in the room.

## EQUALIZATION FALLACY

Can we avoid treating the room acoustically and simply

equalize down the bass in the monitor system? No. Equalization only affects the initial amplitude of the sound; it does not change the rate at which it decays. FIGURE 2 shows what happens when an attempt is made to equalize problems like this. Please note that numbers and pictures are exaggerated here for clarity.

In FIGURE 2 we see that the initial amplitude of the low and high frequencies are both 100 dB. The  $T_{60}$  of the balanced room is one second at all frequencies, so after one second both tones have dropped to 40 dB, which is essentially inaudible. Note that they both fell at the same rate from the same level and crossed the inaudibility threshold at the same time.

In the heavily-carpeted room with the muddy reverb, FIGURE 3, we have attempted to compensate by equalizing down the bass. The  $T_{60}$  of the bass is two seconds, and the  $T_{60}$  of the treble is one second. If we equalized down the bass 30 dB, it would start at an initial amplitude of 70 dB and fall 30 dB in the same time that the high frequencies would fall from 100 dB to 40 dB. Therefore both tones would again become inaudible simultaneously. But we have made the reverberation tonal balance correct at one point only, at 40 dB, which is useless because since the decay times are different at low and high frequencies, the tonal balance is changing throughout the decay period. Also, the direct sound is now totally non-flat.

By contrast, the balanced room of FIGURE 2 has a flat direct sound, an unchanged tonal balance for the entire decay period and both frequencies reach inaudibility together through the whole range. Clearly this is a much more desirable situation than that created in the heavily carpeted, heavily equalized room of FIGURE 3. The wonderful result of this balanced room is that a speaker that is flat in an anechoic chamber will sound flat at the mixer's ears, too, *without equalization*.

## REAL-TIME ANALYZER

Contrary to popular opinion, a real-time analyzer does not display in real time, for if it did our poor slow eyes could not follow it. It integrates the input over a finite time period with a slow decay that makes observing re-

Figure 1. Signal decay under differing conditions.

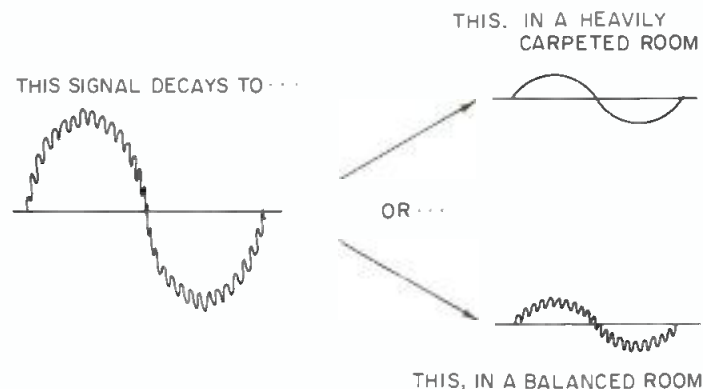

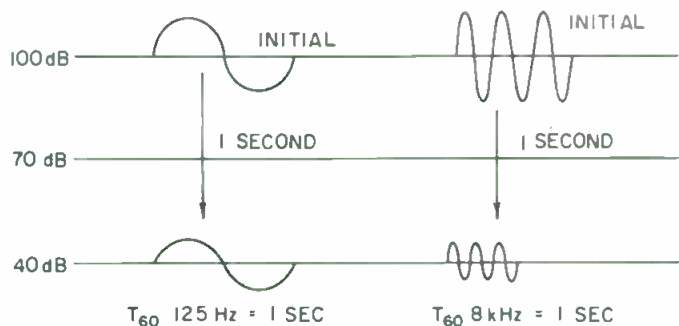

Figure 2. Balanced room decay.

reverberation impossible. On the rta, the reverb of the room adds to the display of the pink noise, and a non-flat reverb characteristic will add more of some frequencies than others.

For example, on the rta, our carpeted room with the muddy reverb will add low end to the display, giving the impression that the initial sound is bass heavy and that equalization is needed. The rta's blind addition of signal and reverb is the root of the problem. Rtas are used with pink noise, which is a *static, continuous sound*, as compared with music and speech which are *impulsive* in nature. Impulse sound is defined by its initial level and time history,<sup>1</sup> and the rta simply adds level and time history together in a way that our ears do not. Our ears hear the effects of room reverb during the pauses of music and speech. Pink noise has no such pauses.

How real is this effect in actual control rooms? Of course, reverberation 20 dB or more below initial levels will not add significantly to the curve height on a rta, but the next 20 dB does. That the reverb is significant in affecting the rta's display is borne out by the fact that in a room with a  $T_{60}$  of 0.2 second, significant reverberant energy exists as close as three feet from the speaker. Obviously this depends upon other factors, most notably speaker Q. But when a speaker whose one foot frequency response of  $\pm 2$  dB becomes  $\pm 12$  dB at 8 feet (this actually occurred in a control room we measured) you can see that the room reflections have a pretty heavy influence.

This wild response was not caused by standing waves. This room was plagued by a non-uniform  $T_{60}$  vs. frequency curve. The ironic part of this story is that the speaker itself is obviously quite flat ( $\pm 2$  dB) and yet the room is giving this speaker a bad reputation ( $\pm 12$  dB). I wonder how many engineers are condemning their innocent speakers!

In addition to all this, equalizing the monitor system makes the important direct sound non-flat! Two rooms, equalized flat, can (and often do) sound different for this reason. Attempting to correct frequency-dependent time decays with initial amplitude equalization is like adding apples and oranges. This basic error occurs regardless of whether you equalize to sine waves, pink noise, or "full-spectrum" pulses.

## ROOM TREATMENT

Properly treating a room is a complex job. What follows is merely a synopsis of common problems and solutions and is not meant to be a do-it-yourself guide to an acoustics diploma. Employing an experienced consultant is a wise decision if your room needs therapy.

Standing waves are a function of room dimensions and shape. Flutter echo is caused by multiple reflections between parallel surfaces. Room modes are room resonances that occur closely spaced in frequency and tend to reinforce their characteristic frequency when it is present in the program material. These problems are minimized by

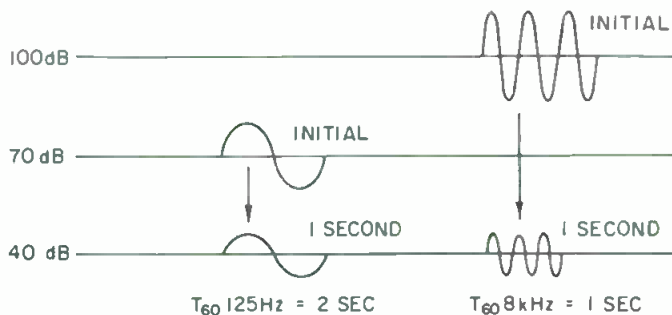

Figure 3. Decay in a room that is heavily carpeted and equalized.

designing a setting with few parallel surfaces, ensuring adequate diffusion and by isolating room-resonant frequencies from each other by choosing optimum room dimension ratios. These are mentioned in Reference 3. Speaker placement can also affect standing waves.

A deep notch, characteristic of a high Q resonator, must be searched out to find out what surface is vibrating. Then stiffen it. These notches show up equally well with rtas and with sine wave reverb measurements. The need for symmetry and stereo separation must be also kept in mind. These problems, although often severe, lay the groundwork for the room  $T_{60}$  analysis.

With the gross problems out of the way, the absorption is added, subtracted, or modified to provide the desired  $T_{60}$  in each frequency band, usually octave bands. This can be planned in advance to an extent by using tables of absorption coefficients that have been published for various building materials. You multiply the square footage of each material by its coefficient at each frequency, and then you add up the total for each frequency and apply this to a  $T_{60}$  equation such as the Norris-Eyring. But since no one has published the absorption coefficient of your console, you'll need to take measurements of the  $T_{60}$  curve. Some may want a control room with a reverb curve approaching that of a typical living room, or perhaps a flat  $T_{60}$  vs. frequency curve is desired.

Finally, an equalizer can be used to fine tune the speaker system if its anechoic chamber response needs changing or if it was never tested in a chamber in the first place due to its custom design (often the case in studios). Usually the difference between one-foot and eight-foot frequency response curves points out the degree to which room reverb is playing a part, and here a rta is handy.

To sum up, control rooms are not equalizers or filters (though they may appear to be on a rta screen). They are time-decay absorbers. Do not correct rooms with amplitude changes (equalization); correct their  $T_{60}$  curves instead.

Equalizers are useful for fine tuning of speaker deficiencies that would show up in anechoic measurements, or for electrical modification of a recorded track, etc. When acoustical changes are not possible, as in many sound-reinforcement applications, equalization has the additional use of allowing increases of acoustic gain if applied properly.<sup>4</sup>

## REFERENCES

1. Beranek, L. L., *Noise Reduction*. McGraw-Hill, New York, N.Y. 1960, pp. 145-151.
2. Rettinger, M., *Acoustic Design and Noise Control*. Chemical Publishing Co., New York, N.Y. 1973, pp. 27-28.
3. Everest, F. Alton, *Acoustic Techniques for Home and Studio*. Tab Books, Summit, Pa., 1973, p. 68.
4. Davis, Don and Carolyn, *Sound System Engineering*. Howard W. Sams & Co. Inc., Indianapolis, Ind., 1975, Chapter 8. ■

MARTIN DICKSTEIN

# Music Alfresco in Central Park

*Reaching an audience of 100,000 while competing with big city traffic and airplane drone is the Central Park assignment.*

**T**HIS MONTH, the N.Y. Philharmonic will be playing its thirteenth season of free open air concerts at Sheep Meadow in Central Park. This will also be the second year for a newly designed sound reinforcement system, and orchestra shell. The tremendous improvement over the previous setup has been noticed and voiced by both the public and music critics. To fully appreciate the achievement involved it's necessary to understand the obstacles that had to be overcome and the requirements set for the project.

The N.Y. Philharmonic usually plays in Avery Fisher Hall at Lincoln Center. These indoor concerts have an audience of about 3,000 people with the most distant seat about 130 feet away. In the open, the same orchestra can play to about 100,000 people, with the outer fringe over 1,000 feet away. Since the area is not far from the busy streets around the park, distractions such as sirens are not uncommon. The Meadow also lies in one flight path of planes going to and from N.Y.'s LaGuardia Airport.

In 1975, before the new system was put in, one newspaper critic, writing about a concert, said that the sound was ". . . pretty good. You have to acclimatize yourself to its obviously tinny, amplified nature but that doesn't take too long." Then, later, he continued with "Out on the periphery . . . with even the closest speaker a long way away, the sound is not very loud. It is thus easy to be distracted by crying babies, noisy vendors and the occasional thoughtless talker or radio player."

To cover the area in question, the previous system utilized eight column speakers mounted over the stage roof, similar units at about 50 feet forward of the stage, and scaffold towers with multiple housings and low and high frequency radial horns at the same distance in front of the stage and about equidistant to either side. During the ten years that the system and stage were in use, the sound shell became less and less efficient, but the sound system was kept working through continuous service.

In 1965, an item of over a half-million dollars was put into the budget for a new shell and sound system. This amount was covered by a grant from the Andrew Mellon Foundation to the N.Y. Philharmonic and the Metropolitan Opera, which also uses the same facilities for its free outdoor concerts in the same locations, and a grant from the Booth Ferris Foundation.

## OUTDOOR SOUND

There are several basic criteria for any outdoor sound

system. The sound must be loud enough and must cover the entire audience, it must be understandable, and must be able to be used for all intended purposes. This new system, however, had another critical requirement. Since the performances of both the Philharmonic and the Met also took place in four other locations in the city in addition to Manhattan, the entire shell, stage, and system had to be made portable. The three-week performances of the Met in June, and the three-week concerts of the orchestra in August take place on consecutive nights (with one rain-out night a week). This meant that the show had to be designed for relative quick set up and tear down.

*This speaker tower is 40 feet high and is rotated 180 degrees on the circular ring directly under the mesh, which protects the speakers from rain. Note the splay of the speakers for total coverage.*



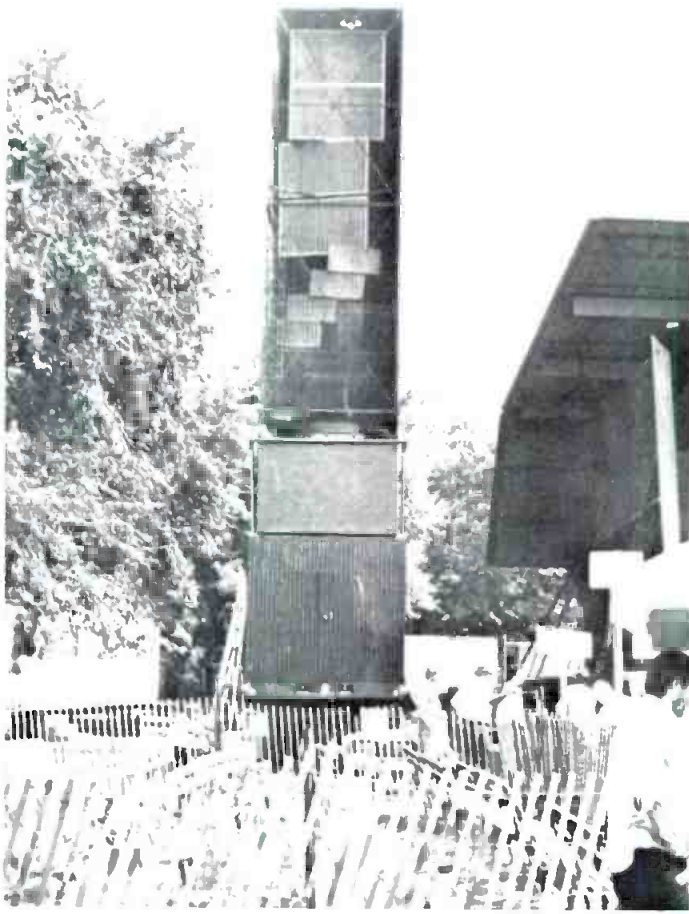

*View of the speaker tower at stage right with positioning for full coverage of audience. The console position is at the lower right.*



*The left of two racks mounted on the speaker tower truck bed has an a.c. line meter, patch and connection panels, a mic mixer, and 4 of the 8 amplifiers in the system.*

Wenger Corporation of Owatonna, Minnesota, had previous experience with designing and building smaller orchestra enclosures incorporated into a truck trailer bed. They were interested in expanding this concept to cover the 40 x 70 ft. stage floor required for this new shell. The acoustical consulting firm of Klepper Marshall King Associates of White Plains, N.Y. was selected to assist with the design of the stage floor and the shell as well as the sound system. To construct and install the new system, Rosner Custom Sound of Long Island City, N.Y. was selected after competitive bidding. Both the consulting and contracting

*Set-up stage, with operating console at lower center of the picture at stage right (where the group is standing). Note one speaker unit in upright position.*

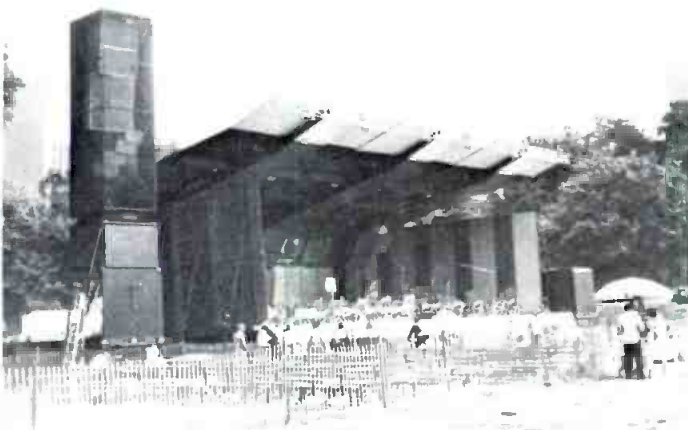

firms have long and impressive records of successful projects and were eminently qualified.

Since Sheep Meadow was the largest of the four areas in which performances were given, this was used as the guide for audience coverage. The live sound from the shell would normally carry satisfactorily to a distance of about fifty feet in front, so the system was designed to cover from fifty feet out to at least 1,000 feet from the front edge of the stage. At the front of the stage, the width of the coverage would be 200 feet each side of the stage center line, and out to 500 feet from the center line at a distance of 1,000 feet from the stage. The frequency response was to be from 63 to 1,000 Hz within 3 dB and at a slope off of 2 dB per octave from 1 kHz to 12.5 kHz, again within 3 dB, and with no peaks outside of this range. Noise and hum were to be inaudible at normal gain settings of the equipment.

The system was required to be able to reinforce live music and speech from anywhere on the stage to a peak level of 105 dB at 150 feet, and 99 dB at 300 feet. The sound, within the area specified and with the levels mentioned, was to be "intelligible and natural sounding." One further requirement of the system was that it was to incorporate existing equipment. This turned out to be no problem because Rosner Custom Sound had kept the units in satisfactory condition for several years.

#### **ACOUSTIC ATMOSPHERE**

The new shell was designed not only for sound distribution to the front audience but to reproduce, with improvements where possible, the previous acoustic atmosphere for the musicians. The honeycomb panels which made up the shell were 1 in. thick around the top and sides, and 2 in.



The two sound racks are located on the speaker tower trailer at truck bed level, with a matching pair on the other truck, each speaker unit operating independently. On the left is a mic mixer, patch and connection panels, a line level a.c. meter, the master switch panel, and 4 amplifiers. The right rack holds 4 amps, the complimiter, the crossover network, equalizer, and notch filter.

on the floor. To help support the weight of the orchestra and a grand piano, ¼ in. thick composition board was laminated to the floor panels. The walls and ceiling were covered with a simulated wood grain veneer.

The entire structure was carefully designed for its proper acoustical function and aesthetics. The walls even included port openings which provided both acoustic treatment and ventilation. The unique shell was constructed in three sections mounted on 40-foot truck trailers. With the truck beds carefully positioned adjacent to each other, the entire shell could be raised hydraulically in place and lowered similarly for moving or storage.

The speaker system was designed as two towers, one on each side of the stage. (Although a single cluster about 40 feet above the stage at the center might have been the ideal solution, the weight could not be supported by the shell ceiling, the proximity to the stage microphones could prove to be an acoustic feedback problem, and the portability requirement added to the need for a different approach.) The towers each contain 28 speakers.

For low frequency (below 500 Hz), eight JBL 2220A 15 in. woofers are housed in four JBL bass horn cabinets. From 500 Hz to 9500 Hz, four long-throw JBL 2356 horns and two short-throw JBL 2350 units are used with 2440 drivers. Above 9.5 kHz, twelve JBL 2405 tweeters are used. For correct phase linearity, all drivers are aligned on the same vertical axis. The speakers are stacked and splayed at specific angles precisely defined for the desired vertical and horizontal coverage. These towers, which rise to a height of forty feet, have the speakers located in the upper twenty feet.

Units in the tower are protected from weather on the sides and back by panels. The front is covered with a fiberglass mesh to prevent direct rain from getting to the speakers. The towers are also designed for mounting on a 28 ft. truck bed. The entire enclosure lies on the bed with the speakers facing down, and thus is completely protected from weather on top and sides. A covering is also used for overall protection during storage periods.

When the two towers are raised hydraulically, they come up facing away from the audience. They are rotated electrically 180 degrees and locked automatically in place for proper orientation. The circular ring permits 360 degree movement in either direction. The speakers are held in place by 2 in. pipe, clamps, and guy wires of aircraft cable. The guy wires are vinyl clad and the connections are covered with caulking compound for weather protec-



16-in/4-out console with each input switchable to any of four line, two echo, and four monitor outputs. Each input also has equalization controls.

tion. The speakers have also been sprayed with a special protective coating for further defense against the elements.

### EQUIPMENT RACKS

The speaker tower truck beds also hold the equipment racks, two for each tower. These are also protected from the weather during storage and operation. Where the previous system was bi-amplified, the present one is tri-powered. There are eight Bozak CMA2-80s per tower. The 15 in. woofers get 80 watts each, the mid-range horns get 40 each, and the tweeters get 20 each. Oil-filled, non-electrolytic capacitors are used between the amplifiers and the tweeter and mid-range drivers to protect them from d.c. in the event of amplifier failure.

The right rack mounted on the truck bed at the foot of the speaker tower contains 4 amps, a complimiter, an equalizer, a notch filter, and a crossover for the speakers. A similar pair of racks is located on the other speaker truck bed.

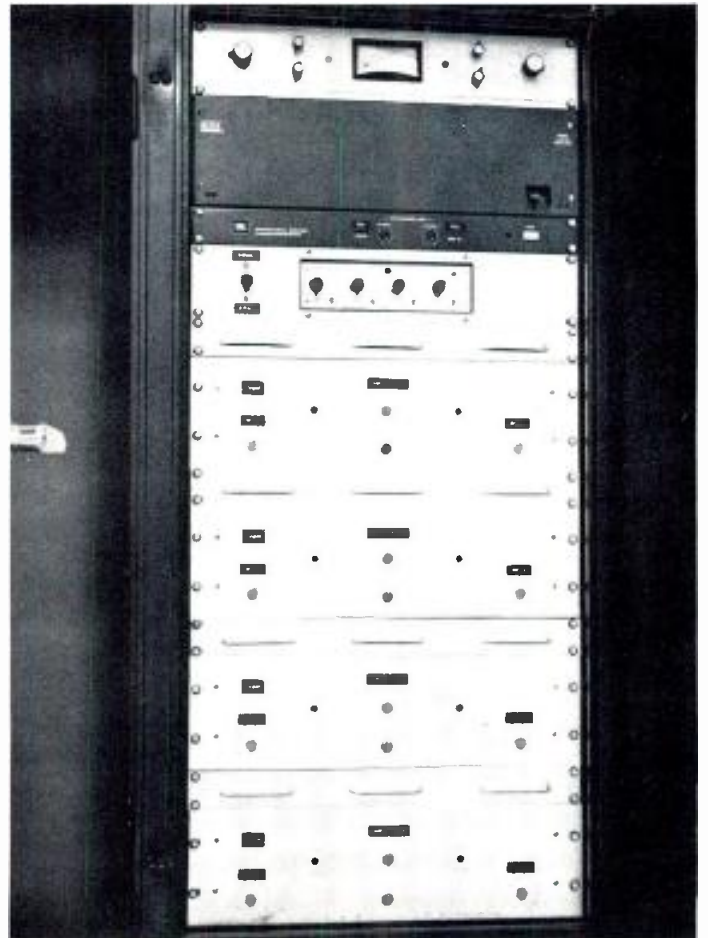



Larry King adjusts a boom microphone, while Alex Rosner (right) checks the positioning.

Alex Rosner at the portable console.



Frequency separation at 500 Hz and 9.5 kHz is handled by a JBI 5234 2-channel electronic crossover network. A UREI 560 tuneable notch filter feeds into the crossover network and receives whatever minor adjustments might be needed for maximum gain before feedback at each performance. The notch filter is fed by an Altec 9860A  $\frac{1}{3}$  octave equalizer. This unit is also adjusted as needed, using pink noise.

Between the equalizer and the external mixing console is a Spectrasonics 610 complimiter to control unusual peaks of incoming sound. Also mounted in each rack is a Shure M-67 mixer/preamplifier. An AKG BX-20 reverb generator and a Gotham Delta-T 101 digital time delay are also available for connecting into the system. With the speaker towers in the lowered position, the racks are completely covered and protected against opening or removal. Access for servicing is from the rear of the racks.

The control console is located at ground level at stage right. It is a Yamaha PM 1000 with 16 channels in and 4 out. Two of the outputs are presently in use, one feeding each amplifier/tower system. (The console can also be used for stereo operation if ever desired.) Each of the inputs is switchable to any of the outputs (four line, two echo, four monitor). Every input has a straight line attenuator control, output assignment switches and variable control equalizers. Each output line has an illuminated vu meter with an overall frequency response, within 1 dB, from 50 to 15,000 Hz at a rated output of plus 18 dBm, with 0.5 per cent or less harmonic distortion. The console comes in a protective carrying case for portability.

When the system was fully installed and tested, it was found, after adjustment of the  $\frac{1}{3}$  octave equalizer to the



Still weather-protected, the left speaker tower is raised from the truck bed into its upright position.

The audience can number up to 100,000, with some listeners well over 1,000 feet from the stage.



specified slope, that it was possible to achieve 108 dB at 150 feet, 3 dB more than the specifications called for, with some headroom still left. The gain was left at that point. This setting gave a level of over 100 dB at 300 feet. The noise was far below ambient sound and completely inaudible.

The entire system, including the three trucks for the shell and stage and the two for the towers, met the requirements for mobility and could be set up by a crew of 14 stagehands and 9 teamsters. The total system weighs in at over 50 tons. In addition to these five, there are also separate dressing room units, and a generator truck.

The new system has met with critical acclaim. Following a performance by the Metropolitan Opera during the 1976 season, a music critic for the *N.Y. Times* wrote that "The system... performed astonishingly well. A wanderer through the Sheep Meadow found that the voices came through clearly with recognizable color and individuality..."

Two months later, during the Philharmonic performances, the same critic wrote an article indicating his dislike for amplified systems outdoors and that the ideal would be for the same 100,000 people not to listen to one concert outdoors but for 1,000 to listen to 100 individual indoor concerts. Following a Philharmonic concert in the '76 season, another music critic for the same newspaper wrote "Let others cavil at the misery of amplified music: this night it gave pleasure to 100,000 New Yorkers, and not many other things do nowadays." A tip of the hat to David Klepper of Klepper Marshall King and Alex Rosner of Rosner Custom Sound for a job well done and also for their assistance in getting the material and pictures for this article together. ■

# BGW Model 100-01 Power Amplifier

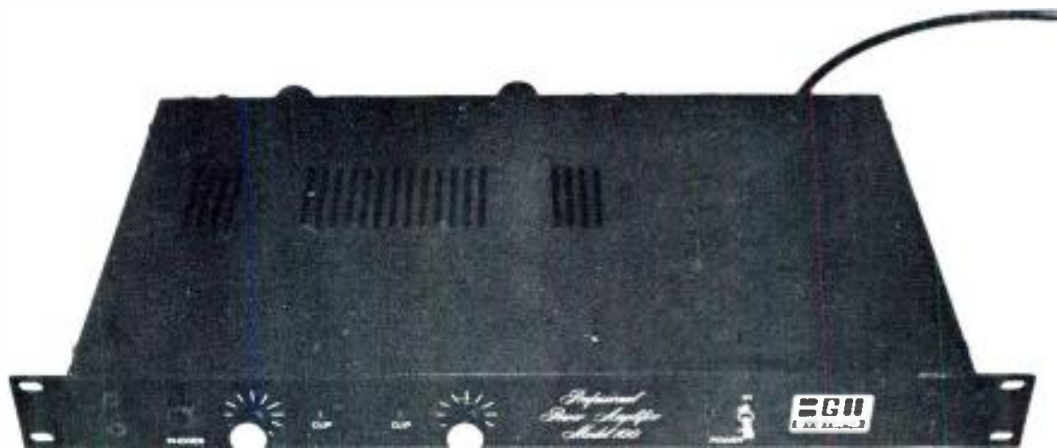

*The BGW 100-01 Power Amplifier.*

**N**OT every need for a studio power amplifier demands super high power that also goes along with a super high price. To meet this need, several manufacturers have developed moderate power units that meet both full professional standards of performance, and yet still give high-fi standards of sound quality. The latest of these is this new BGW Model 100-01, the 01 designation indicating a balanced line, transformer-possible input. The amplifier is also available without this option, whereby it is only unbalanced in.

The Model 100 is nominally rated by BGW as a 30-watt per channel stereo amplifier. This is probably a worst-case designation since, as will be seen, our sample (at least) performed rather better than that.

Physically, the unit takes up very little rack space—1.75

inches to be exact—and is but twelve inches deep. It weighs a hefty eighteen pounds, testimony to its massive heat sinks which contribute to the unit's conservative design.

The front panel is simple in layout with input gain pots for the two channels and a pair of red light-emitting diodes that are designed to ignite when the output is at clipping level, or when it is shut down due to a short.

The rear panel has the input and output connections. Input is via xlr-type connectors. An octal plug is next to each input. An appropriate transformer or a (supplied) jumper plug must be inserted here. Outputs are by paired banana-plug lugs, so you can use single or double jacks, wire wraps, lugs, just about anything that will make contact will do nicely.

The a.c. cord is heavy duty and is a three-wire type with



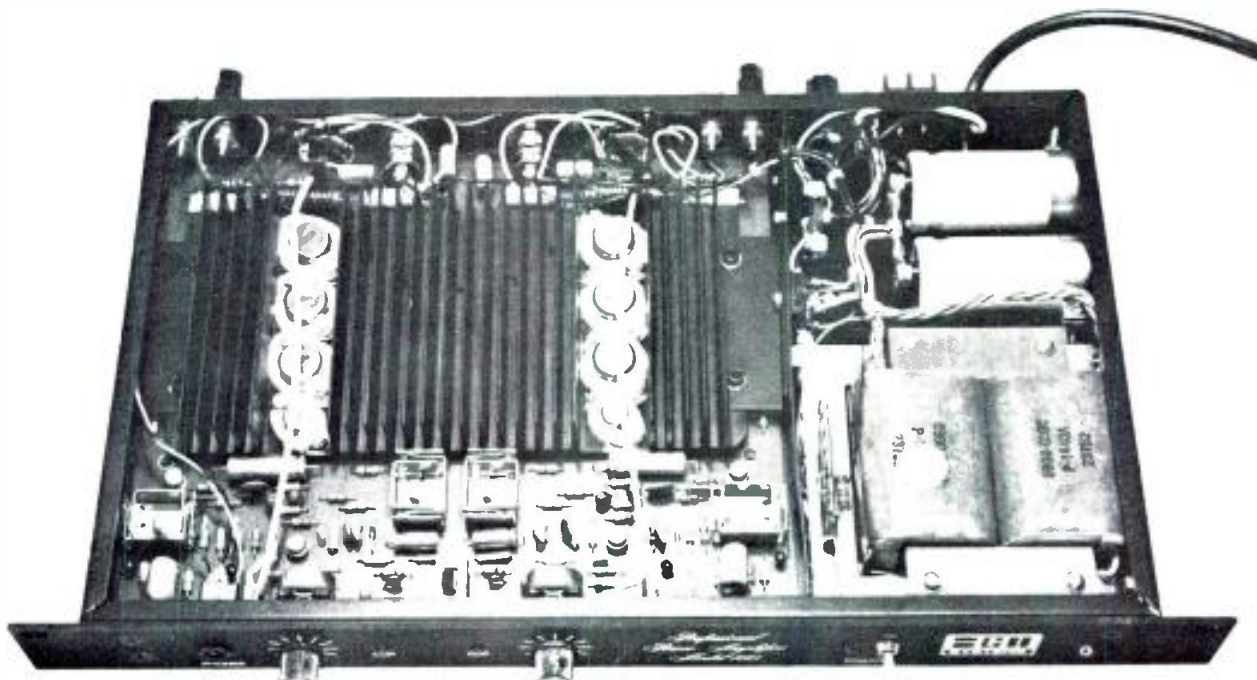

*With the top cover removed, the clean construction becomes obvious. Note the massive heat sinking.*

*The heavy heat sinks on the output devices, along with their high power rating in excess of 120 watts, ensures conservative operation at all times.*

ground. While the standard amplifier is provided for 120V operation, it can also be used on 220 volts by means of a rear switch, and a recommended change of power-fuse rating.

Once installed, the amplifier will properly feed any line that is at least presenting a 4 ohm load to the outputs. The front panel contains a stereo headphone jack. The internal connections to this jack have a 270-ohm resistor in series with the hot sides so that gain to the headphones is under control. Also, headphone insertion does not materially affect the load to the amplifier output.

One final physical fact about this amplifier is that it may be internally bridged to become a more powerful mono amplifier. This entails removing the top panel, flipping an internal switch, and making speaker contact thereupon to the two hot sides of the output. You will now have a mono power output of 80 watts.

## LAB TESTS

No tests were made of the mono ability of the amplifier. Its stereo performance, however is exemplary in that it not only met all its published specs, but was often orders of magnitude better.

The full rated advertised power at 8 ohms is 30 watts minimum sine wave continuous average power output per channel, with both channels driving 8-ohm loads over a power band of 20 Hz to 20 kHz. The maximum total harmonic distortion at any power level from 250 milliwatts to 30 watts shall be no more than 0.1 per cent.

Here's what was found in the lab: Power at clipping level with both channels driven into 8-ohm loads was measured at 34 watts per channel midband, and 32 watts per channel at the power extremes. Harmonic distortion measured at both 20 Hz and 20 kHz 30 watts out resulted in t.h.d. numbers of 0.0028 per cent at the bass end, and 0.062 per cent at 20 kHz.

There are no published specs on intermodulation dis-

tortion, but I measured it using the standard SMPTE 4:1 ratio (60-6,000 Hz). At full power of 30 watts, the Model 100's i.m. distortion is 0.0037 per cent. It is also the same at small signal levels of 1-3 watts.

Frequency bandwidth at these levels extends 1 Hz to 69 kHz. The envelope for that range is +0, -3 dB. Within the 20-20,000 Hz range, you can draw the frequency response with a ruler. As might be expected with this kind of bandwidth, low frequency square waves revealed virtually no tilting, and higher frequencies showed no ringing or rolloffs.



*Rear view of the amplifier showing connections.*

And if you need a low noise amplifier, this unit's broadband noise measured -107 dB below 30 watts output. Input sensitivity for full output is achieved with 0.78 volts.

Finally, a check was made to see what happens if the load is 4 ohms rather than the stated and tested 8 ohms. Power is greater, of course; now you can have 48 watts per channel under the same driven conditions as before. And distortion did not materially change. When a deliberate short was introduced in the output, the amplifier quickly shut down, and the front panel l.e.d. ignited. Removing the short restored power quickly.

The BGW Model 100-01 is rugged and will surely give long professional service. L.Z. ■

**Now  
available  
in  
paperback  
too!**

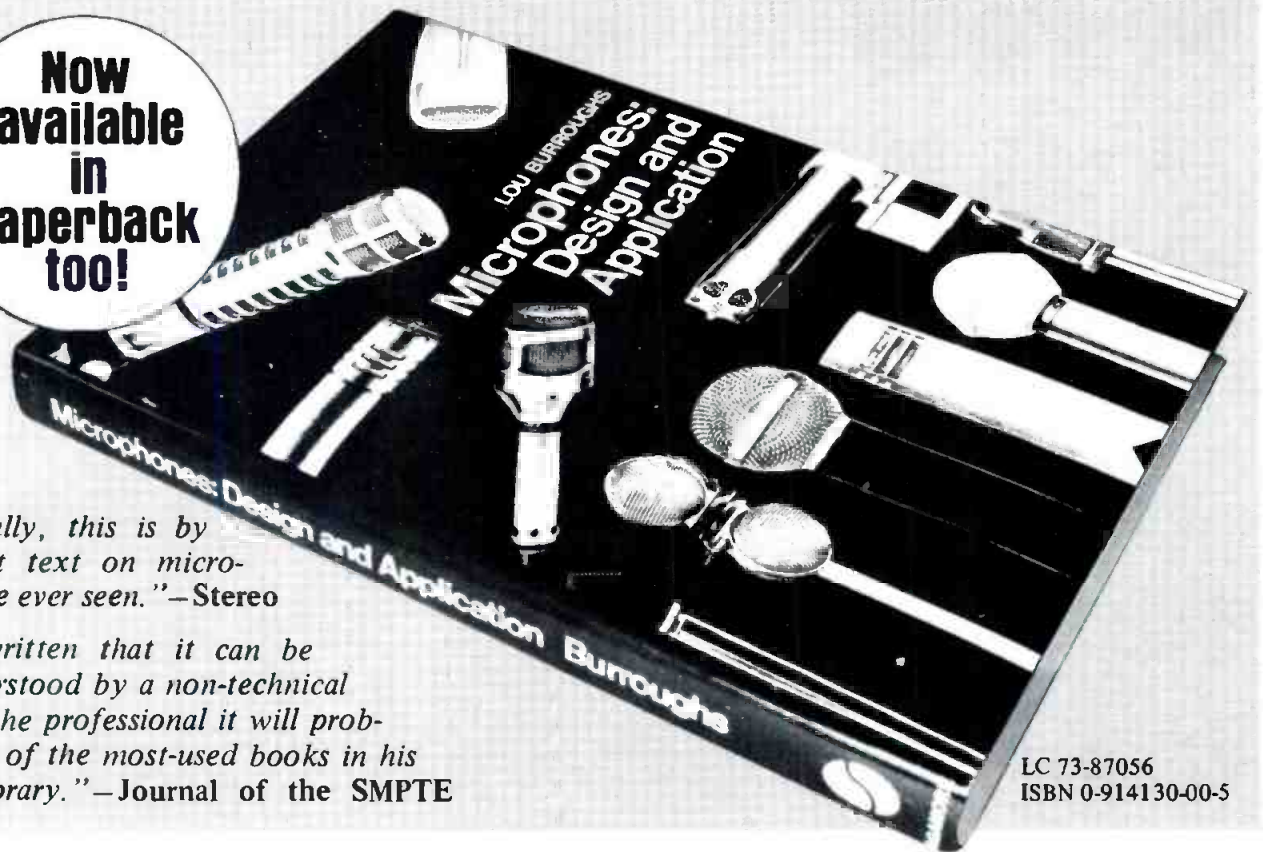

*"Unequivocally, this is by far the best text on microphones we've ever seen."*—Stereo

*"So well written that it can be clearly understood by a non-technical person; for the professional it will probably be one of the most-used books in his reference library."*—Journal of the SMPTE

LC 73-87056  
ISBN 0-914130-00-5

And the rave reviews go on and on. "At last... a decent book on microphones," said David Lane Josephson in *Audio*. "Excellent chapters on various aspects of microphones, which are discussed in great detail," said Werner Freitag in *The Journal of the AES*.

They're applauding **Microphones: Design and Application**, by Lou Burroughs, who has written this practical, non-theoretical reference manual for everyone involved in the application of microphones for tv, motion pictures, recording and sound reinforcement.

Twenty-six fact-packed chapters cover the field of microphones from physical limitations, electro-acoustic limitations, maintenance and evaluation to applications, accessories and associated equipment. Each chapter is crammed with experience-tested, detailed information, and clear, precise diagrams and illustrations that complement the text.

Along with down-to-earth advice on trouble-free microphone applications, Lou Burroughs unfolds dozens of invaluable secrets learned during his more than three decades of achievement in the field. He solves the practical

"The chapter headings give a clear idea of the down-to-earth contents of the book... each chapter contains advice, direction, suggestions and warnings couched in the clearest and most unambiguous language possible." (*Journal of the SMPTE*.) Here are all 26 chapters.

- Microphone Techniques
- The Polar Response of a Microphone
- Microphone Types
- Microphone Loading
- Rating Microphone Sensitivity
- Microphone Overload
- Proximity Effect
- Temperature and Humidity Extremes
- Microphones Electrically Out of Phase
- Microphone Interference
- Acoustic Phase Cancellation and the Single Microphone
- Microphone Maintenance (this chapter alone "is worth the price of the book" said D.F. Mikes in *Audiovisual Instruction*)
- Comparing Microphones with Dissimilar Polar Patterns
- The Monitor Speaker
- Wide-Range vs. Controlled-Range Frequency Response
- Choosing Between an Omni-Directional and a Cardioid Microphone
- The Omni-Directional Microphone for Orchestral Pickups
- Assembling a Superior Bi-Directional Microphone
- The Two-to-One Ratio
- Miking for the Drama
- Miking the Theatre for Audience Reaction
- Wind Screens
- Microphones on Booms
- Acoustic Separators and the Omni-Directional Microphone
- The Hand-Held Microphone
- The Lavalier Microphone

problems you meet in everyday situations, such as:

- When would you choose a cardioid, omni-directional, or bi-directional mic?
- How are omni-directional mics used for orchestral pickup?
- How does dirt in the microphone rob you of response?
- How do you space your microphones to bring out the best in each performer?

**Microphones: Design and Application.** As *Stereo* put it, "It's a hard book NOT to learn from." Order your copies today.

Sagamore Publishing Co., Inc.  
1120 Old Country Road,  
Plainview, N.Y. 11803

Yes! Send MICROPHONES: DESIGN AND APPLICATION.

—hardcover edition(s) @ \$20.00  
—paperback edition(s) @ \$12.95

Name \_\_\_\_\_

Address \_\_\_\_\_

City/State/Zip \_\_\_\_\_

Total Amount \$ \_\_\_\_\_

N.Y.S. Residents add 7% sales tax \$ \_\_\_\_\_

Enclosed is check for \$ \_\_\_\_\_

Outside U.S. add \$1.00 for postage.

# db Classified

Closing date is the fifteenth of the second month preceding the date of issue.

Send copies to: Classified Ad Dept.

db THE SOUND ENGINEERING MAGAZINE

1120 Old Country Road, Plainview, New York 11803

Rates are 50¢ a word for commercial advertisements.

Employment offered or employment wanted ads are accepted at 25¢ per word.

Frequency discounts: 3 times, 10%; 6 times, 20%; 12 times, 33%.

db Box number: \$1.00 per issue.

All classified ads must be prepaid. Frequency discount advertisements are to be prepaid in advance.

## FOR SALE

SOUND SYSTEM design and installation, loudspeaker enclosures for professional applications, custom passive crossover assemblies, room equalization, road equipment cases, touring sound rental. **K&L Pro Audio, 75 N. Beacon St., Watertown, Mass. (617) 926-6100.**

RAZOR BLADES, single edge; tape editing. **RALTEC, 25884 Highland, Cleveland, Ohio 44143.**

MEASURE ROOM ACOUSTICS professionally. Acoustilog's Model 232 Reverberation Timer incorporates the following advantages: one-person operation, 3% accuracy, internal pink noise generator, 3-digit readout. **Acoustilog, 19 Mercer St., New York, N.Y. 10013. (212) 925-1365.**

AMPEX SPARE PARTS; technical support; updating kits, for discontinued professional audio models; available from **VIF International, Box 1555, Mountain View, Ca. 94042. (408) 739-9740.**

MCI 24-TRACK recording console with producer's desk; matching equipment rack; plus extras. \$19,500. **(312) 225-2110, Paul.**

CROWN INTERNATIONAL. Complete repair; overhaul, and rebuilding service for current and early model Crown tape recorders and amplifiers. New and reconditioned recorders in stock for immediate delivery. Used Crown recorders purchased and accepted for trade in. **TECHNIARTS, 8555 Fenton St., Silver Spring, Md. 20910. (301) 585-1118.**

TWO EVENTIDE digital delay lines, like new. \$2,300.00 each. **(212) 765-7790. Soundesigns, Inc.**

MXR'S DIGITAL DELAY system. Maxell tape, all widths, discounted. **N.A.B. Audio, Box 7B, Ottawa, Ill. 61350.**

A FEW competitively priced used Revox A77 and A700 decks available. Completely reconditioned by Revox, virtually indistinguishable from new and have the standard Revox 90-day warranty for rebuilt machines. Satisfaction guaranteed. Write requirements to **ESSI, Box 854, Hicksville, N.Y. 11802. (516) 921-2620.**

STUDIO SOUND—Europe's leading professional magazine. Back issues available from January '74 through June '75. \$1 each postpaid. **3P Recording, P.O. Box 99549, San Francisco, Ca. 94109.**

TECHNIARTS, professional audio equipment: AKG, Ampex, Crown International, dbx, Malatchi, Orban Parasound, Sescam, in stock. Professional audio services: audio and acoustical analysis, narrow band equalization, reverberation time, frequency response, and noise level measurements, broadcast and recording systems design, fabrication, and installation. **TECHNIARTS, 8555 Fenton St., Silver Spring, Md. 20910. (301) 585-1118.**

TASCAM 80-8's in stock; Loft Modular recording consoles; AKG, Shure, E-V, and Sennheiser microphones; AKG reverb; Eventide; Crown; Parasound; Sentry III's and IVB's. Call today, ask for Ben at **Rowton Professional Audio, Paducah, Ky (502) 898-6203.**

SOUNDCRAFT MIXING CONSOLES for recording and sound reinforcement available exclusively in New England at: **K&L Pro Audio, 75 N. Beacon St., Watertown, Mass. 02172. (617) 926-6100.**

COMPUMIX-i 24-channel mixing system, self contained, perfect condition, interfaces to any board, \$10,000. Ampex MM-1100 16-track, \$15,000. Both \$23,000. AG-440-4C plus 2-track block, console \$4,600. TM-499 digital delay, \$1,800. All items 10 months old. **(303) 499-0545 evenings.**

SOUNDESIGNS, authorized 3M dealership and repair service; carrying all professional machines and parts: 24, 16, 8, 4, 2-track, Selectake I and II. Call **Soundesigns, Inc., Artie Johnson, at (212) 765-7790.**

RACK LABS active fixed or variable frequency crossovers, disco mixers, and ULF (subsonic) filters. Write: **136 Park St. New Haven, Ct. 06511.**

# Neve

NEW AND USED  
MIXING CONSOLES  
SALES-RENTAL-LEASE

NEW 24 TRACK CONSOLES, often available from stock or on short notice. Budgetary prices are: Model 8058, 28-in, \$66,900. Model 8068, 32-in, \$77,900. Model 8084 32 + 8-in, \$89,900. Get all the details on these and other price-competitive consoles, built to the highest standards. Leasing programs available, subject to terms.

TRADE-IN CONSOLES in excellent condition may be available from time to time, due to our many satisfied customers wishing to upgrade to larger Neve consoles. Typical prices are: Model 8014, 16-in/8 track \$20,000. Model 8036, 24-in/16 track, \$40,000. Model 8048, 32-in/24 track, \$70,000. Leasing programs available, subject to terms.

RENTAL CONSOLES may be available for short use. Typical monthly rates are: Model 8301, 10-in/2-out, \$550. Model 5305, 20-in/4-out, \$1,200. Model 8036, 24-in/16-track, \$2,200. Model 8058, 28-in/24-track, \$2,800. Weekly rates upon request. Subject to terms and availability. All prices are subject to change without prior notice. FOB points are Bethel, Conn. or Toronto, Ontario. Sales and use taxes not included.

**Rupert Neve Incorporated**  
Berkshire Industrial Park  
Bethel, Conn. 06801  
(203) 744-6230  
In Canada (416) 677-6611

### NAGY SHEAR-TYPE TAPE SPLICERS



FOR CASSETTE ¼ & ½ IN. TAPES  
• HAND-CRAFTED  
• FIELD PROVEN  
• FAST, ACCURATE  
• SELF-SHARPENING

NRPD Box 289 McLean, Va. 22101

### FREE CATALOG & AUDIO APPLICATIONS



CONSOLES  
KITS & WIRED  
AMPLIFIERS  
MIC, EQ, ACN,  
LINE, TAPE, DISC,  
POWER  
OSCILLATORS  
AUDIO  
TAPE BIAS  
POWER SUPPLIES

OPAMP LABS, INC.  
1032 N. ST. CARMON, AVE.  
LOS ANGELES CALIF 90038  
(213) 934-3346

TASCAM, TEAC, Sound Workshop, Nakamichi, Otari, dbx, MXR, Dynaco, ADS, Eventide, E-V, Shure, Maxell, Ampex, AKG Pro, Beyer, UREI, Stax, Sennheiser, TAPCO, BGW, and more! Send for price quotes. **Zimet Pro Audio, Dept. DB, 1038 Northern Blvd., Roslyn, N.Y. 11576.**

THE LIBRARY . . . Sound effects recorded in STEREO using Dolby throughout. Over 350 effects on ten discs. \$100.00. Write **The Library, P.O. Box 18145, Denver, Colo. 80218.**

TRACKS!! The complete semi-pro recording center. Check our low prices on Tascam, TEAC, Neotek, Micmix, dbx, Multi-Track, MXR, Sennheiser, BGW, Shure, TAPCO, and many others. Complete studio packages available. **TRACKS!! from DJ's Music, Ltd. 9520 47th St., Brookfield, Ill. 60513. (312) 485-0020.**

THE RESONATOR is more than a reverb. Designed for use with any console, including Tascam. \$359.00. **Dyma, Box 1697, Taos, N.M. 87571.**

MODERN RECORDING TECHNIQUES by Robert E. Runstein. The only book covering all aspects of multi-track pop music recording from microphones through disc cutting. For engineers, producers, and musicians. \$9.95 prepaid. **Robert E. Runstein, 44 Dinsmore Ave. Apt. 610, Framingham, Mass. 01701.**

\$2 MILLION USED RECORDING EQUIPMENT. Send \$1.00 for list, refundable, to **The Equipment Locator, P.O. Box 99569, San Francisco, Ca. 94109.**

#### PRO AUDIO EQUIPMENT & SERVICES

P.A. and custom touring sound systems, studio equipment, and turnkey installations, theatre and disco sound. Representing over 100 lines, including: AKG, Allen & Heath, Alembic, Community Light & Sound, dbx, Denon, Dokorder, Dynaco, Emilar, ESS-Pro, E-V, Forsythe Audio, Fons, Furman, Gallien-Kruger, Gale, Gauss, Goldring, Grace, J&H Formula 4, Kelsey, Koss, Lamb, Langevin, 3M, 3A, Marantz, Meteor, Mitsubishi, Maxell, Malatchi, MXR-Pro, Otari, Russound, Revox, SAEC, Sennheiser, Scotch, Shure, Sonab, Sound Craftsman, Soundcraft, Sound Workshop, Sony, Switchcraft, Sesscom, Stax, Supex, TAPCO, TDx, Tascam, Technics, TEAC, Thorens, Uher, West Penn. All equipment on display in a working environment. Competitive pricing and comprehensive service.

**K&L Pro Audio, 75 N. Beacon St., Watertown, Mass. 02172 (617) 926-6100 (Att. Ken Berger)**

#### AUDIO and VIDEO On a Professional Level

Lebow Labs specializes in equipment sales, systems engineering, and installation—full service and demonstration facilities in-house. We represent over 200 manufacturers of professional and semi-professional equipment for recording, broadcast, sound reinforcement, and for commercial sound. Call or write for information and pricing.

**LEBOW LABS, INC.  
424 Cambridge St.  
Allston (Boston) Mass. 02134  
(617) 782-0600**

AMPEX TAPE. Ampex Audio studio mastering tapes; 631-641, 406-407, and "Grand Master" in stock for immediate shipment; ¼", 1" and 2"; factory fresh. Best prices. **Techniarts, 8555 Fenton St., Silver Spring, Md. 20910. (301) 585-1118.**

TEST RECORD for equalizing stereo systems. Helps you sell equalizers and installation services. Pink noise in ⅓ octave bands, type QR-2011-1 @ \$20. Used with precision sound level meter or B & K 2219S. **B&K Instruments, Inc., 5111 W. 164th St., Cleveland, Ohio 44142.**

AMPEX, SCULLY, TASCAM, all major professional audio lines. Top dollar trade-ins, 15 minutes George Washington Bridge. **Professional Audio Video Corporation, 342 Main St., Paterson, N.J. 07505. (201) 523-3333.**

AMPEX SERVICE COMPANY: Complete factory service for Ampex equipment; professional audio; one-inch helical scan video; video closed circuit cameras; video systems; instrumentation and consumer audio. Service available at **2201 Lunt Avenue, Elk Grove Village, IL 60007; 500 Radier Drive, Glendale, CA 91201; 75 Commerce Way, Hackensack, NJ 07601.**

AUDIOARTS ENGINEERING parametric equalizer, electronic crossover, disco mixer, stage mixers. **Audioarts Engineering, 286 Downs Rd., Bethany, Conn. 06525.**

REELS AND BOXES 5" and 7" large and small hubs; heavy duty white boxes. **W-M Sales, 1118 Dula Circle, Duncanville, Texas 75116. (214) 296-2773.**

MAXELL, AMPEX, Capitol and Columbia reel tape; bulk and custom loaded. Custom length duplicator cassettes. Reels, boxes, leader tape, splicers. For complete catalog, write **Omega Audio Products, Box 39253, Redford, Michigan 48239.**

CUTTERHEAD REPAIR SERVICE for all models Westrex, HAECO, Grampian. Modifications done on Westrex. Avoid costly down time; 3-day turnaround upon receipt. Send for free brochure: **International Cutterhead Repair, 194 Kings Ct., Teaneck, N.J. 07666. (201) 837-1289.**

SPECTRA SONICS custom console 16 x 16, 32 pan pots. Currently in use; good quiet board. \$11,000 or best offer. **Fifth Floor Recording. (513) 651-1871.**

LIGHTING DIMMER SYSTEM for sale. 32 — 3k dimmers, 32 faders with 16 preset memory console. Packed for touring. Must sell! **BC&G Enterprises, P.O. Box 1036, Littleton, Colorado 80160. (303) 751-5991.**

4560 KIT! Using new Community fiberglass flare and one sheet of plywood. Use 15" speaker of your choice. Only \$115! Order now from **Gary Gand Music, 172 Skokie Valley Rd., Highland Park, Ill. 60035. (312) 831-3080.**

24-CHANNEL Sound Reinforcement Mixer, 100-ft. snake, balanced input, 3-band eq., 3 submixers, monitor, echo, solo. Also UREI Model 527A Graphic Equalizer. Best offer! **BC&G Enterprises, P.O. Box 1036, Littleton, Colorado 80160. (303) 751-5991.**

PIEZO SUPER TWEETERS. Good quantities in stock; specifications sent if requested. \$4.62-\$9.50, depending on quantity. **Musimatic, Inc., 4187 Glenwood Rd., Decatur, Ga. 30032. (404) 289-5159.**

SOUND WORKSHOP mixing consoles, reverbs and support equipment setting new standards in the semi-pro industry available in New England at: **K&L Pro Audio, 75 N. Beacon St., Watertown, Mass. 02172. (617) 926-6100.**

PROFESSIONAL SOUND COMPONENTS from Crown, TAPCO, Soundcraft, Eventide, Community, Malatchi, Tascam, Bi-amp, dbx, Gauss, Spider/Peavey, Sound Workshop, and many more. Hear it all at **Gary Gand Music, 172 Skokie Valley Rd., Highland Park, Ill. 60035. (312) 831-3080.**

INCREASE YOUR USABLE P.A. SYSTEM'S POWER WITH BODE FEEDBACK SUPPRESSOR. MODEL 741XR

Also featuring a complete line of studio and performance frequency shifters. For details contact:

**Bode Sound Co.  
1344 Abington Pl.  
N. Tonawanda, N.Y. 14120  
(716) 692-1670**

SPECTRA SONICS, 20 input, 16 bus; 16-track monitor with 2 cue feeds, 2-position eq., selectable frequency, cue and echo send; stereo/mono busses. Currently installed; converting room to a 24-track system. Highest bid. Contact **Larrabee Sound, (213) 657-6750.**

AST: THE PROFESSIONAL SOUND STORE. Full line of ALTEC, CROWN, CERWIN-VEGA, E-V, GAUSS, SHURE, SUNN, and ATLAS pro sound equipment; factory authorized service on most speakers. Large stock of ALTEC, CERWIN-VEGA and E-V replacement diaphragm assemblies available. **AST, 281 Church St., New York, N.Y. 10013. (212) 226-7781.**

NEW CUSTOM CONSOLE, factory warranted, original customer unable to take delivery. Construction stopped at point where expansion above original 10-in/8-out configuration is possible. 3-band/9 frequency equalizer on inputs and echo return. Ultra-quiet electronics with +26 dBm output. Terms available. Call **Gordon: Clark Research Co., 59-101st St., Ft. Lee, N.J. 07024. (201) 947-4810.**

VEGA 4-track 1/2-in. deck, identical to Ampex AG-440; new Electro-Sound pinch roller; STL alignment tape; 5 reels unused tape. \$2,500.00. **Harry Minot, 81 Olcott Way, Ridgefield, Conn. 06877. (212) 754-1100.**

STAGE / STUDIO / BROADCAST audio systems: AKG, Allison Research, Amber, Amco, Audiotronics, Beyer, Cannon, dbx, E-V, Eltech, Eventide Clockworks, Ivie, JBL, Lexicon, MicMix, MRL, Nagra, Neotek, Neumann, Nortronics, Orban/Parasound, Orange County, Otari, Pultec, Robins, Russco, Scully, Sennheiser, Sescom, Shure, Sony, Soundcraft, Speck, Switchcraft, Spectra Sonics, 3-M, Tascam, U.M.C., White, & UREI, plus many more. For further information on these and other specialty items from our factory operations contact: **Midwest Sound Co., 4346 W. 63rd St., Chicago, Ill. 60629. (312) 767-7272.**

TWO AMPEX MM-1000 16-track recorders, excellent condition. Priced for quick sale. **(212) 765-7790. Soundesigns, Inc.**

PARTS IN STOCK for Ampex, Bose, TEAC, Crown, SAE, Uher. Also fast professional service to your equipment. **Jones Electronics, 947 Old York Rd., Abington, Pa. 19001. (215) 885-4190.**

8-TRACK RECORDERS, excellent condition. Ampex MM-1000 and Scully 280, \$6,300 each, firm. **Datacope. (501) 666-8588.**

REVOX A700 stereo 1/2-track recorder, N.A.B. adaptors, excellent, \$1,440. Stelavox SP7 stereo 1/2-track portable plus accessories, excellent, \$2,200. **Gerald Whelan, 8747 Twin Creek Dr., Franklin, Ohio 45005.**

ONE SCULLY 100 16-track recorder, good condition. \$10,500.00 **(212) 765-7790. Soundesigns, Inc.**

STEINWAY GRAND PIANOS bought, sold, rebuilt. **(212) 693-1363.**

TASCAM Model 5 console, \$1,250. Also Gallien Krueger 4002 series bass bottom. \$250. Both units new. **(516) 751-8389.**

### BUSINESS OPPORTUNITIES

RECORDING STUDIO. Professional 8-track sound studio currently operating in the Washington, D.C. area. Good location with room for expansion and good potential. \$30,000 takes all or will sell equipment individually. For more information and equipment list write **Dept. 71, db Magazine, 1120 Old Country Rd., Plainview, N.Y. 11803.**

### WANTED

EQUIPMENT WANTED: NEUMANN; AKG, Sennheiser microphones; miscellaneous outboard gear, etc. Call or write: **Dan Alexander, 1345 Grove St., Berkeley, Ca. 94709. (415) 232-7933.**

WANTED: BULK CASSETTE duplication, using mono heads only. VERY picky about quality. 1/4" running master supplied. Send prices 100, 500, 1,000. **Sound By Blachly, Box 4328, Austin, Texas 78765.**

WANTED: TRANSCRIPTION discs. any size, speed. Radio shows. music. **Box 724-db, Redmond, Wa. 98052.**

### EMPLOYMENT

TM PRODUCTIONS, largest radio commercial and ID firm, is now screening applicants for top engineering/mixing position. Must be a dedicated pro, and one of the best. Exceptional sense of organization and efficiency essential. Unlimited opportunities with the fastest growing production house in the U.S. Send resume, sample mixes, and salary requirements to **Ken Justiss, Operations Mgr., TM Productions, 1349 Regal Row, Dallas, Texas 75247. Absolutely no phone calls accepted.**

APPLIED AUDIO WRITER/CONSULTANT. National consumer audio-music magazine based in New York seeks experienced journalist with solid background in professional recording techniques, electronics, and electronic musical instruments. Send resume and writing samples to **Dept. 81, db Magazine, 1120 Old Country Rd., Plainview, N.Y. 11803.**

EXPERIENCED MUSIC MIXER  
Major N.Y.C. studio. New automated 24-track. Send resume to **Dept. 83, db Magazine, 1120 Old Country Rd., Plainview, N.Y. 11803.**

PROFESSIONAL AUDIO SERVICE technician, part time, with opportunity for full-time if satisfactory. Metropolitan Washington, D.C. area. Send background and experience to **db Magazine, Dept. 82, 1120 Old Country Rd., Plainview, N.Y. 11803.**

WANTED: Young, gifted sound engineer for college studio. Thorough understanding of mechanics, multiple-track recording equipment and capacity to do "mixing." Ours is the most sophisticated production program in the Midwest and with a sound facility that is first-rate but eclectic—an improved collection of machinery that requires talented attention. The right person for this job probably functions comfortably as a film sound man, has a mechanical aptitude, and might want to be a mixer one day or run his own sound studio. He should be committed to film. Salary negotiable. The right person might also teach on a part-time basis. An added attraction is the fact that we are central to film action in Chicago and that means the possibility of free lance work, additional income. Send resume, stressing background, credits, capacity, etc., addressed to: **Anthony Loeb, Chairman, Film Department, Columbia College, 600 S. Michigan Ave., Chicago, Ill. 60605. An equal opportunity employer.**

PROJECT MANAGER/ENGINEER to take charge of design, fabrication, and installation of complex professional sound systems for large auditoriums, arenas, buildings, etc. You must have an EE degree or equivalent experience, and a proven record of accomplishments. Position offers significant individual recognition. Age no hindrance. This is a new position in our expanding engineering department and is an excellent opportunity to join the national leader. Salary open. Phone or write, **Mr. David Butz in strict confidence. New Jersey Communications Corporation, Kenilworth, N.J. 07033. (201) 245-8000.**

POSITIONS AVAILABLE. Concert sound/lighting/scenic technicians and engineers needed. MUST have road experience and references. Full-time, salaried employment. Send resume or call the **Alpha Organization, 6910 Raleigh La Grange Rd., Memphis, Tenn. (901) 388-1032.**

## Audio Circuit Design Engineer

Due to recent expansion and increased business activities UREI has an opening for a product designer. Applicant must have substantial experience in all phases of audio circuit design, B.S. preferred. UREI offers competitive salaries and excellent benefits.

UREI

8460 San Fernando Road  
Sun Valley, Calif. 91352

Forward resumes to R.B.Combs

# db People/Places/Happenings

● An American subsidiary, based in Chicago, has been set up by British **Audio & Design Recording**. The new company, operating under the name of **Audio & Design Recording, Inc.**, is located at 1019 N. Winchester, Chicago, Ill. 60622. Officers of the company include president **Gregg Dixon**; chairman, **Mike Beville**; vice presidents, **Ian Harley**, **Steve Miller**, and **Len Lewis**.

● International shuffling has been taking place at **Spectrol Electronics Corp.**, of City of Industry, Ca. **Roger Jones** is being transferred to Swindon, England as general manager of Spectrol Reliance, Ltd. **Martin Hankinson**, formerly managing director of the Swindon operation, is returning to California, to become director of marketing. **Lee Chapman** is returning from chores at SP Elettronica spa in Milan, Italy to California to become manager of Spectrol Electronic Controls. His place is being taken by **George Artiano**.

● A line of electronic musical instruments has been accumulating at fledgling **Aries Music, Inc.** of Salem, Mass. founded last April. Principals in the firm are **Robert A. Snowdale**, **Jim Bastable**, and **June Richards**. Production centers around the Aries 300 series of modules, first manufactured in 1974.

● Referring to the school as "a well-established San Francisco educational institution which provides exceptional training to its students." Mayor **George Moscone** recently issued a special proclamation saluting the **College for Recording Arts**. **Leo de Gar Kulka**, dean of the college, was also personally congratulated by Mayor Moscone for the guidance he offers his students. The college is located at 665 Harrison St., San Francisco.

● **Daniel E. Denham**, vice president of the **3M Company Recording Materials Group**, was recently named the **International Tape Association/Time, Inc.'s** Man of the Year. The citation, presented by **Fred Bronner** of Time, Inc., highlighted Mr. Denham's efforts in establishing minimum world-wide standards for tape production.

● Announcement has been made of the appointment to **Leon Wortman** to the post of marketing manager at **Otari Corporation**, of San Carlos, Ca. Mr. Wortman had been active in sales in the **Ampex** and **Scully** companies before coming to Otari.

● Record-breaking demand for space at the forthcoming (October 16-21) **SMPTE Conference** has led to the establishment of 72 additional booths. Site of the conference is the Century Plaza Hotel in Los Angeles. For information, contact SMPTE, 862 Scarsdale Ave., Scarsdale, N.Y. 10583.

● **The Elrep Sales Company** of Tucker Ga. has been appointed to represent **AKG Acoustics** of Mahwah, N.J. in handling dealer relations. **Ben Van de Kreke**, president of Elrep, is the contact person.

● Representatives in 17 cities have been chosen to handle the Syn-Aud-Con three-day sound engineering seminars conducted by **Don and Carolyn Davis** of **Synergetic Audio Concepts**, Tustin, Ca. The coordinators include **Forti-Austin Associates**, Billingsboro, N.J.; **Bidwell Sales Assoc.**, Carson, Ca.; **Moulthrop Sales, Inc.**, Oakland, Ca.; **Fleehart & Sullivan, Inc.**, Seattle, Wa.; **Dobbs-Stanford Corp.**, Irving, Tx.; **Forristal-Young Sales Co.**, Kansas City, Mo.; **Jamieson & Associates, Inc.**, Minneapolis, Mn.; **Ray R. Hutmacher Assoc.**, Chicago, Ill.; **McFadden Sales**, Columbus, Oh.; **Diversified Concepts**, Marcellus, N.Y.; **Irv Bron Company**, Brooklyn, N.Y.; **Ballou & Assoc.**, Southington, Ct.; **Lineau Assoc., Inc.**, Rockville, Md.

● Two sophisticated tape-to-disc mastering facilities manufactured by **Neumann** of West Berlin and installed by **Gotham Audio Corporation** of New York and Hollywood have been placed in San Juan, Puerto Rico at **Ochoa Recording Studios** and at **Diskwerks, Inc.** of Schaumburg, Ill. The Ochoa system has an A-80 preview tape machine, SP-75 program console, Neumann VMS-70 computer disc cutting lathe and SX-74 stereo cutterhead. The Diskwerks system also includes the first SP-77 transfer console ever installed.

● Hungarian-produced Videoton stereo speaker systems are now available to Northwest users through newly appointed representative **Spectrum Northwest Marketing, Inc.** of Portland, Oregon. Spectrum will market the speakers in Oregon, Washington, Montana, Idaho, and Hawaii. The national outlet for Videoton is **Kelso Imports**, of New York City.

● **Charles Condike** has been promoted to the position of vice president of the distributor division of **Robins Industries Corporation**, of Commack, N.Y. Before joining Robins in 1976, Mr. Condike was with **British Industries Company**. Another promotion is the appointment of **Steven N. Friedman** as vice president of professional products. Mr. Friedman had been serving as senior engineer for the firm.

● Returning to West L.A. **Music** in Los Angeles after an interim with **Sunn Musical Equipment** in Portland. **Gregg Hildebrandt** has assumed the post of vice president and general manager of the L.A. firm. West L.A. Music is a retail outlet for musical instruments, sound systems, and recording equipment.

● Supplying the professional recording industry, as well as sound reinforcement and semi-pro audio needs, **Audio Marketing, Ltd.**, has been formed as a wholly owned subsidiary of **Audiotechniques**, of Stamford, Conn. **Richard Anderson**, former product manager at Audiotechniques, will serve as the general manager of the new company.

● The need for a ten-second delay device for television electronic news gathering equipment was stressed recently by **Robert Flanders**, vice president of engineering at **McGraw-Hill Broadcasting Company** and chairman of the NAB Engineering Advisory Committee. With the proliferation of live t.v. news broadcasts, the danger exists of exposing the public to an uncontrolled situation unless some means is found to blank out transmission in an emergency. With split second timing at stake, Mr. Flanders feels that an electronic pausing device is an urgent priority.

Nearly every concert tour by a "super group" in recent years has had its origin at Showco. We design and build the huge, high-level sound systems, intricate lighting and special effects systems, and provide the stage designs for over 1000 concerts a year. At the conclusion of the tour, the tapes that we produce have resulted in best-selling "live" albums.

Now, through Showco Manufacturing Corp., we are bringing this same highly acclaimed expertise into discotheque sound systems. We are in full production of the S-2500 Disco Mixer, S-2501 Electronic Crossover Network, and our concert proven Pyramid\* 1000 and 900 speaker systems designed to be suspended from the ceiling or to be floor mounted with the optional base. Developments are underway for still other new and innovative products. Call or write for the name of your nearest dealer.

# THE DISCO SOUND SYSTEM FROM SHOWCO

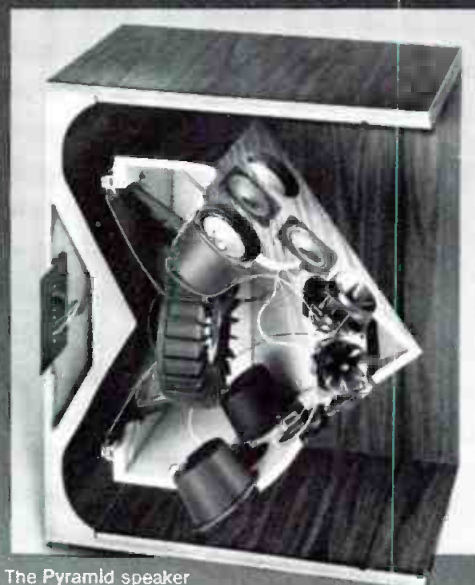

The Pyramid speaker incorporates a unique fully symmetrical folded bass horn which in turn allows the mid and hi frequency drivers to be optimally mounted for wide dispersion. The overall result is a single full range, high level, extremely efficient cabinet ideally suited to discotheques.



SHOWCO MANUFACTURING CORPORATION  
1225 Round Table Drive / Dallas, Texas 75247  
Phone (214) 630-7121 TWX (910) 861-4278

\*U.S. Patent No. 3,912,866

Circle 11 on Reader Service Card

# Now there's a JBL monitor specially designed for broadcast studios.

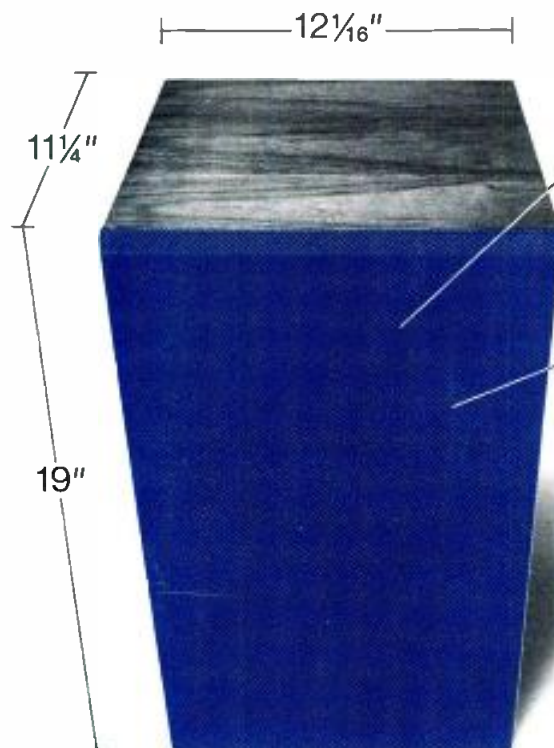

Fits on EIA  
Standard Rack shelf.

Does your monitor  
tell you about turn-  
table rumble and  
ambient noise (like  
your air conditioning)  
and tape hiss and  
cue tone leakage?  
The JBL 4301 will.

Our call letters.  
If you're tuned into the  
professional recording  
studio business, you  
know about JBL's  
studio monitors.

If you're the station engineer or the jock on duty, why should you be the last to know what sound you're putting out?

Listen to the JBL 4301. It's a compact that delivers wide band sound reproduction accuracy—the kind of accuracy your station is going to need to keep up with the new broadcast standards.

Among other good things, the 4301 has exceptional clarity, solid bass, open high frequency reproduction and a nice honest face.

If you'll fill out the coupon, we'll send you a lot more specs and the name of your nearest JBL Professional Products Dealer who would be very glad to set up a test listening at your convenience.

**JBL**

James B. Lansing Sound, Inc.  
Professional Products Division  
8500 Balboa Blvd., Northridge, Calif. 91329

I like what I hear so far. Tell me more.

Name \_\_\_\_\_

Title \_\_\_\_\_

Station \_\_\_\_\_

Address \_\_\_\_\_

City \_\_\_\_\_ State \_\_\_\_\_ Zip \_\_\_\_\_

DB-8